



POLARIS
RZR

2024

ACCESSORIES,
GARAGE & APPAREL

EMEA VERSION

ACCELERATE BEYOND

THE EVERYDAY



#RZRLife

LIVE THE LIFESTYLE.
JOIN THE COMMUNITY.

LINEUP

TRAIL

TRAIL S

P. 60



RZR TRAIL S

MULTI-TERRAIN

XP

P. 36



2024 RZR XP



2024 RZR XP 4

PRO XP

P. 04



RZR PRO XP SPORT



RZR PRO XP ULTIMATE

WIDE OPEN

TURBO R & PRO R

P. 04



RZR TURBO R



RZR TURBO R ULTIMATE



RZR PRO R



RZR PRO R 4

YOUTH

P. 106

CONTENTS

PRO R, TURBO R & PRO XP 04

AUDIO	22
WINDSHIELDS & REAR PANELS	24
ROOFS, DOORS & HEATER	26
VEHICLE PROTECTION	28
LIGHTING	30
STORAGE	32
MISC, MIRRORS & WINCHES	34

XP 36

AUDIO	42
WINDSHIELDS & REAR PANELS	44
ROOFS, DOORS & HEATER	46
VEHICLE PROTECTION	48
LIGHTING	50
STORAGE	52
MIRRORS & WINCHES	54
2014-2023 XP 1000, XP TURBO & TURBO S	56

TRAIL S 60

WINDSHIELDS & REAR PANELS	66
ROOFS, DOORS & AUDIO	68
VEHICLE PROTECTION & STORAGE	70
WINCHES, HEATER & PLOWS	72
LIGHTING, ELECTRICAL & TRACKS	74

COMMON ACCESSORIES 76

LIGHTING	76
CONNECTED TECHNOLOGY	82
PRO ARMOR WHEELS & TIRES	84
POLARIS NORTHSTAR COOLERS	100
COCKPIT ACCESSORIES & MIRRORS	102
WINCHES	104
ADDITIONAL ACCESSORIES	106

YOUTH 106

PARTS & GARAGE 108

MAINTENANCE	108
OIL & LUBRICANTS	110
MAINTENANCE FLUIDS	112
HD PARTS	114
SERVICE PARTS	116
CLEANERS & TRAILERING	119

APPAREL 120

RACING COLLECTION	124
JERSEYS, GLOVES & HEATED APPAREL	124
HELMETS & GOGGLES	126
RZR APPAREL	128
MEN'S APPAREL	130
BALL CAPS	134
CAMO APPAREL	135
WOMEN'S APPAREL	136
HOME & COLLECTIBLES	138

DESIGNED by the people who designed your vehicle.

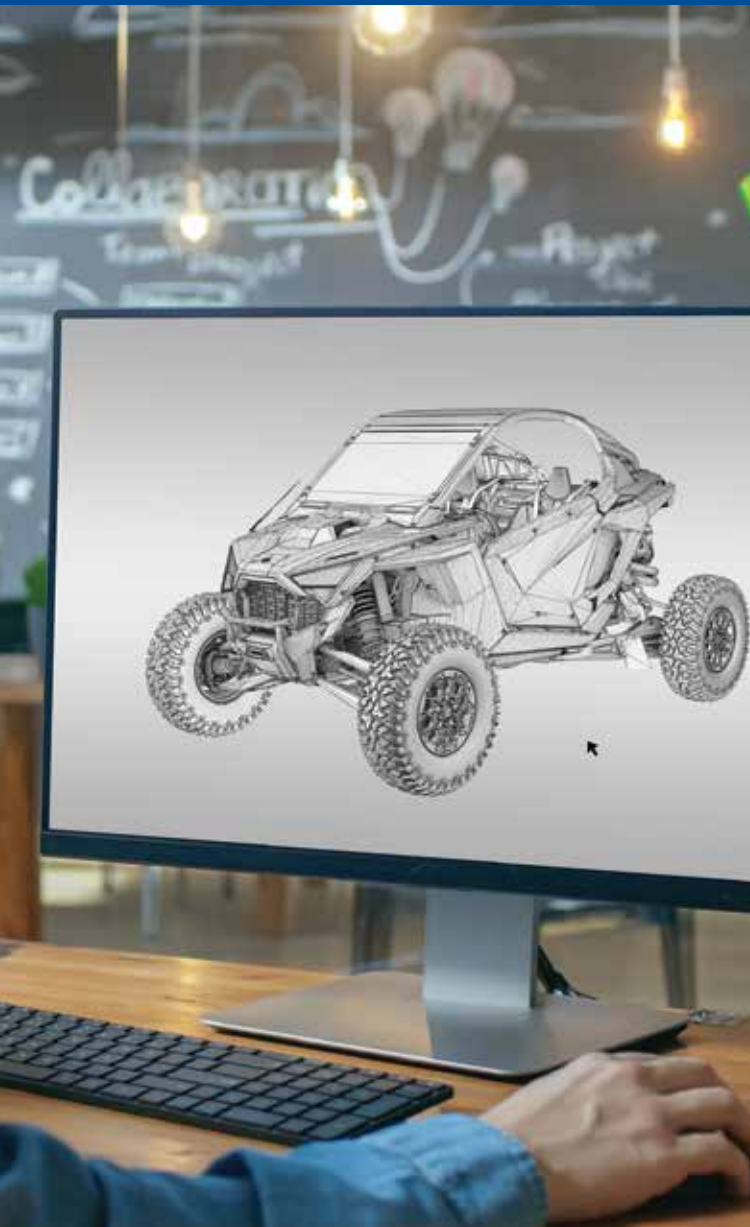

TESTED extensively in the field so you ride with 100% confidence.



TRUSTED 65 years in the business. The #1 name in Off Road.



WE HOLD OUR PARTNERS TO THE SAME STANDARDS



PREMIUM AFTERMARKET OPTIONS DESIGNED WITH POLARIS TO MAXIMIZE PERFORMANCE
P. 81, 84



A GLOBAL LEADER IN AUDIO INNOVATION, DESIGN AND ENGINEERING
P. 22, 42, 69



PRODUCTS SO GOOD THEY REPLACE OR REPAIR THEM FOR LIFE
P. 30, 50, 80



MILITARY-GRADE AIR FILTRATION THAT KEEPS YOUR AIR FILTER CLEAN AND ENGINE PROTECTED
P. 34

POLARIS RZR PRO R



POWER | STRENGTH | CONTROL



RIGID CHASE LIGHT
SEE P.31

> OPTIMAL PERFORMANCE

Easy customization solutions designed to fit perfectly and mount effortlessly.

ROCKFORD FOSGATE AUDIO P.22
PROTECTION P.28
RIGID LIGHTING P.30
POLARIS PULSE P.31



PLUG & PLAY ELECTRICAL

EFFORTLESSLY ADD
LIGHTS, AUDIO & WINCH



> TOTAL RELIABILITY

Personalized comfort with end-to-end protection from the elements.

WINDSHIELDS P.25
REAR PANELS P.25
DOORS P.27



> UNRIVALED FLEXIBILITY

Accessory options to give you even more reason to get out and stay riding.

STORAGE P.32
COOLERS P.33
PRO ARMOR WHEELS & TIRES P.34



> DUNE COLLECTION

Carve through the soft sands and tackle each hill with confidence.

2884746	LOCK & RIDE HALF WINDSHIELD- HARD COAT POLY, LOW	P. 25
2884325-458	ALUMINUM ROOF, 4-SEAT*	P. 26
2884660-458	ALUMINUM DOORS, 4-SEAT	P. 27
2884354-458	FRONT PRE RUNNER BUMPER	P. 29
2883763	PREMIUM CONVEX REARVIEW MIRROR	P. 34

2883857	STAGE 3 AUDIO UPGRADE BY ROCKFORD FOSGATE*	P. 22
2883945	REAR SPEAKER PODS BY ROCKFORD FOSGATE*	P. 22
2884648	RIGID® SR-SERIES 81.3 cm COMBO LED LIGHT BAR	P. 30
2884601	81.3 cm LIGHT BAR MOUNT	P. 30
2889130	POLARIS PULSE HD LIGHT BAR HARNESS	P. 30

2884359	RIGID® CHASE LIGHT	P. 31
2884896	CHASE LIGHT MOUNT KIT	P. 31
2889034	CHASE LIGHT HARNESS KIT	P. 31
2884235	LOCK & RIDE 57 L FORWARD CARGO BOX	P. 32

2889740	LOCK & RIDE 22 L REAR COOLER	P. 33
2889784	7 L DOOR STORAGE BAG	P. 33
2885020	PRO ARMOR WHEEL & TIRE SET: 5207/5303 & SAND 16XT, 32"	P. 99

Shown on Pro R 4-Seat.
*Aluminum roof comes stock on Premium/Ultimate models.



DESERT COLLECTION

Dominate rocky environments and charge through endless miles of hard-pack terrain.



RUGGED TRAIL COLLECTION

Take on unpredictable landscapes and climb to new heights for epic views.

2884747	LOCK & RIDE FULL VENTED WINDSHIELD - HARD COAT POLY, 4-SEAT	P. 25
2884325-458	ALUMINUM ROOF, 4-SEAT*	P. 26
2884355-293	FRONT PRE RUNNER WINCH BUMPER	P. 29
2884358-293	REAR PRE RUNNER BUMPER	P. 29
2889209-293	HD EXTREME KICK-OUT ROCK SLIDERS, 4-SEAT	P. 29
2883763	PREMIUM CONVEX REARVIEW MIRROR	P. 34
2883762	ADJUSTABLE FOLDING SIDE MIRRORS	P. 34
2884648	RIGID® SR-SERIES 81.3 cm COMBO LED LIGHT BAR	P. 30
2884601	81.3 cm LIGHT BAR MOUNT	P. 30
2889130	POLARIS PULSE HD LIGHT BAR HARNESS	P. 30

2884359	RIGID® CHASE LIGHT	P. 31
2884896	CHASE LIGHT MOUNT KIT	P. 31
2889034	CHASE LIGHT HARNESS KIT	P. 31
2884235	LOCK & RIDE 57 L FORWARD CARGO BOX	P. 32
2889740	LOCK & RIDE 22 L REAR COOLER	P. 33
2884326-458	PIVOTING SPARE TIRE CARRIER	P. 33
2884341	POLARIS PRO HD 2,721 kg WINCH	P. 35
2885012	PRO ARMOR WHEEL & TIRE SET: 5302 & PRO RUNNER, 33"	P. 98
5417533	PRO ARMOR SPARE TIRE: PRO RUNNER, 33"	P. 89
1524038	PRO ARMOR SPARE WHEEL: 5302, 15"	P. 97

Shown on Pro R 4-Seat.
*Aluminum roof comes stock on Premium/Ultimate models.

2884350	FULL VENTED WINDSHIELD - GLASS, 2-SEAT	P. 25
2884352	LOCK & RIDE POLY REAR PANEL, 2-SEAT	P. 25
2884237-458	ALUMINUM ROOF, 2-SEAT*	P. 26
2884658	FRONT DOOR INNER CLOSOFF PANELS, 2-SEAT	P. 27
2884353-458	FRONT HIGH COVERAGE BUMPER	P. 28
2884356-458	REAR HIGH COVERAGE BUMPER	P. 28
2884685	FULL COVERAGE FENDER FLARES	P. 28
2883763	PREMIUM CONVEX REARVIEW MIRROR	P. 34
2883762	ADJUSTABLE FOLDING SIDE MIRRORS	P. 34
2884256	PMX-P2 HEAD UNIT BY ROCKFORD FOSGATE®	P. 22

2883943	STAGE 2 AUDIO KIT BY ROCKFORD FOSGATE®	P. 22
2883857	STAGE 3 AUDIO UPGRADE BY ROCKFORD FOSGATE®	P. 22
2889790	PRO ARMOR 12.2 CM DUAL-ROW LED LIGHT BAR	P. 81
2889130	POLARIS PULSE HD LIGHT BAR HARNESS	P. 81
2412616	ADAPTER HARNESS	P. 81
2884235	LOCK & RIDE 57 L FORWARD CARGO BOX	P. 32
2889785	9 L SHOULDER STORAGE BAG	P. 33
2884341	POLARIS PRO HD 2,721 kg WINCH	P. 35
2885014	PRO ARMOR WHEEL & TIRE SET: 5206 & CRAWLER XR, 33"	P. 99

Shown on Pro R 2-Seat.
*Aluminum roof comes stock on Premium/Ultimate models.

POLARIS RZR TURBO R



POWER | STRENGTH | CONTROL



> SUPERIOR INNOVATION

Seamlessly integrated technology offerings that take your ride to the next level.

ROCKFORD FOSGATE® AUDIO P.22
RIGID® LIGHTING P.30
POLARIS PULSE P.31
INTEGRATED WINCH P.35



PLUG & PLAY ELECTRICAL
EFFORTLESSLY ADD LIGHTS, AUDIO & WINCH



> ENDLESS CUSTOMIZATION

A complete accessory lineup developed to fit the needs of every riding style.

STORAGE P.32
COOLERS P.33
PRO ARMOR WHEELS & TIRES P.84



> UNRELENTING TOUGHNESS

Expertly engineered products that are sure to stand up to the elements.

WINDSHIELDS P.25
ROOFS P.26
PROTECTION P.28



DESERT COLLECTION

Dominate rocky environments and charge through endless miles of hard-pack terrain.

2889019	FULL VENTED WINDSHIELD - GLASS	P. 25
2890145	GLASS WINDSHIELD WIPER KIT	P. 25
2883990-458	ALUMINUM ROOF, 4-SEAT*	P. 26
2884355-458	FRONT PRE RUNNER WINCH BUMPER	P. 29
2884585-458	REAR PRE RUNNER BUMPER	P. 29
2889209-458	HD EXTREME KICK-OUT ROCK SLIDERS, 4-SEAT	P. 29

2883763	PREMIUM CONVEX REARVIEW MIRROR	P. 34
2883762	ADJUSTABLE FOLDING SIDE MIRRORS	P. 34
2889463	STAGE 5 AUDIO UPGRADE BY ROCKFORD FOSGATE*	P. 22
2884648	RIGID® SR-SERIES 81.3 cm COMBO LED LIGHT BAR	P. 30
2884650	81.3 cm LIGHT BAR MOUNT	P. 30
2889130	POLARIS PULSE HD LIGHT BAR HARNESS	P. 30

2884359	RIGID® CHASE LIGHT	P. 31
2884896	CHASE LIGHT MOUNT KIT	P. 31
2889034	CHASE LIGHT HARNESS KIT	P. 31
2883751	LOCK & RIDE 70 L FORWARD CARGO BOX	P. 32
2889740	LOCK & RIDE 22 L REAR COOLER	P. 33
2884666	LOCK & RIDE 72 L MULTI-PASSENGER REAR SEAT CARGO BOX	P. 33

2889784	7 L DOOR STORAGE BAG	P. 33
2889404-458	PIVOTING SPARE TIRE CARRIER	P. 33
2884341	POLARIS PRO HD 2,721 kg WINCH	P. 35
2885008	PRO ARMOR WHEEL & TIRE SET: 5302 BEADLOCK & CRAWLER XR, 33"	P. 99
5417174	PRO ARMOR SPARE TIRE: CRAWLER XR, 33"	P. 90
1524038	PRO ARMOR SPARE WHEEL: 5302 BEADLOCK, 15"	P. 96

Shown on Turbo R 4-Seat.
*Aluminum roof comes stock on Premium/Ultimate models.



> DUNE COLLECTION

Carve through the soft sands and tackle each hill with confidence.

2884746	LOCK & RIDE HALF WINDSHIELD - HARD COAT POLY, LOW	P. 25
2883991-458	LIGHT POCKET ALUMINUM ROOF, 4-SEAT	P. 26
2884660-458	ALUMINUM DOORS, 4-SEAT	P. 27
2884354-293	FRONT PRE RUNNER BUMPER	P. 29
2883763	PREMIUM CONVEX REARVIEW MIRROR	P. 34
2884256	PMX-P2 HEAD UNIT BY ROCKFORD FOSGATE*	P. 22
2883943	STAGE 2 AUDIO KIT BY ROCKFORD FOSGATE*	P. 22
2884655	STAGE 4 AUDIO UPGRADE BY ROCKFORD FOSGATE*	P. 22
2883945	REAR SPEAKER PODS BY ROCKFORD FOSGATE*	P. 22
2884074	RIGID® SR-SERIES 71.1 cm COMBO LED LIGHT BAR	P. 30

2889130	POLARIS PULSE HD LIGHT BAR HARNESS	P. 30
2884359	RIGID® CHASE LIGHT	P. 31
2884896	CHASE LIGHT MOUNT KIT	P. 31
2889034	CHASE LIGHT HARNESS KIT	P. 31
2884346	ACCENT LIGHT	P. 31
2883752	LOCK & RIDE 40 L REAR CARGO BOX	P. 32
2883424	POLARIS NORTHSTAR 28 L COOLER	P. 33
2884070	LOCK & RIDE NORTHSTAR 28 L COOLER BRACKET	P. 33
2889784	7 L DOOR STORAGE BAG	P. 33
2885020	PRO ARMOR WHEEL & TIRE SET: 5207/5303 & SAND 16XT, 32"	P. 99

Shown on Turbo R 4-Seat.



> RUGGED TRAIL COLLECTION

Take on unpredictable landscapes and climb to new heights for epic views.

2884305	LOCK & RIDE FULL VENTED WINDSHIELD - HARD COAT POLY	P. 25
2883757	LOCK & RIDE POLY REAR PANEL, 2-SEAT	P. 25
2883743-458	ALUMINUM ROOF, 2-SEAT*	P. 26
2884353-458	FRONT HIGH COVERAGE BUMPER	P. 28
2884189-458	REAR HIGH COVERAGE BUMPER	P. 28
2889208-458	HD EXTREME KICK-OUT ROCK SLIDERS, 2-SEAT	P. 29
2883763	PREMIUM CONVEX REARVIEW MIRROR	P. 34
2883762	ADJUSTABLE FOLDING SIDE MIRRORS	P. 34
2884655	STAGE 4 AUDIO UPGRADE BY ROCKFORD FOSGATE*	P. 22
2889791	PRO ARMOR 83.8 cm COMBO LED LIGHT BAR	P. 81
2889130	POLARIS PULSE HD LIGHT BAR HARNESS	P. 81

2412616	ADAPTER HARNESS	P. 81
2883751	LOCK & RIDE 70 L FORWARD CARGO BOX	P. 32
2883752	LOCK & RIDE 40 L REAR CARGO BOX	P. 32
2889785	9.5 L SHOULDER STORAGE BAG	P. 33
2889784	7 L DOOR STORAGE BAG	P. 33
2889404-458	PIVOTING SPARE TIRE CARRIER	P. 33
2884340	POLARIS PRO HD 2,041 kg WINCH	P. 35
2885018	PRO ARMOR WHEEL & TIRE SET: 5206 & PRO RUNNER, 33"	P. 98
5417533	PRO ARMOR SPARE TIRE: PRO RUNNER, 33"	P. 89
1524041	PRO ARMOR SPARE WHEEL: 5206, 15"	P. 96

Shown on Turbo R 2-Seat.
*Aluminum roof comes stock on Premium/Ultimate models.

POLARIS RZR PRO XP



MOST VERSATILE & CAPABLE RZR



RIGID CHASE LIGHT
SEE P.31

> UNMATCHED ENGINEERING

Next-level innovation makes this RZR unlike anything you've ever owned.

ROCKFORD FOSGATE AUDIO P.22
RIDE COMMAND P.22
RIGID LIGHTING P.30
POLARIS PULSE P.31
INTEGRATED WINCH P.35



PLUG & PLAY ELECTRICAL
EFFORTLESSLY ADD
LIGHTS, AUDIO & WINCH



> VISIONARY DESIGN

Relentless attention to detail delivers extraordinary style and function for the ultimate ride.

WINDSHIELDS P.25
ROOFS P.26
DOORS P.27
MIRRORS P.34



> ELEVATED FUNCTIONALITY

An unrivaled selection of accessories gives you even more reason to get out – and stay out – riding.

PROTECTION P.28
STORAGE P.32
PRO ARMOR WHEELS & TIRES P.84



» DESERT COLLECTION

Dominate the rocky landscape and charge through endless miles of desert.

2889019	FULL VENTED WINDSHIELD - GLASS	P. 25
2890145	GLASS WINDSHIELD WIPER KIT	P. 25
2883990-458	ALUMINUM ROOF, 4-SEAT	P. 26
2883749-458	FRONT HIGH COVERAGE BUMPER	P. 28
2884189-458	REAR HIGH COVERAGE BUMPER	P. 28
2884359	RIGID CHASE LIGHT	P. 31
2884896	CHASE LIGHT MOUNT KIT	P. 31

2889034	CHASE LIGHT HARNESS	P. 31
2883751	LOCK & RIDE 70 L FORWARD CARGO BOX	P. 32
2889740	LOCK & RIDE 22 L REAR COOLER	P. 33
2884666	LOCK & RIDE 72 L MULTI-PASSENGER REAR SEAT CARGO BOX	P. 33
2889404-458	PIVOTING SPARE TIRE CARRIER	P. 33

Shown on Pro XP 4-Seat.



» TRAIL COLLECTION

Navigate the trails through forests, hills and plains.

2883756	LOCK & RIDE FULL VENTED WINDSHIELD - HARD COAT POLY	P. 25
2883928	POLY SPORT ROOF, 2-SEAT	P. 26
2883749-458	FRONT HIGH COVERAGE BUMPER	P. 28
2884189-458	REAR HIGH COVERAGE BUMPER	P. 28
2889208-458	HD EXTREME KICK-OUT ROCK SLIDERS, 2-SEAT	P. 29

2883751	LOCK & RIDE 70 L FORWARD CARGO BOX	P. 32
2883752	LOCK & RIDE 40 L REAR CARGO BOX	P. 32
2889784	7.25 L DOOR STORAGE BAG	P. 33
2889404-458	PIVOTING SPARE TIRE CARRIER	P. 33
2883758	POLARIS PRO HD 2,041 kg WINCH	P. 35

Shown on Pro XP 2-Seat.



> MOUNTAIN COLLECTION

Climb pristine mountain trails for an epic view.

2883756	LOCK & RIDE FULL VENTED WINDSHIELD - HARD COAT POLY	P. 25
2883928	POLY SPORT ROOF, 2-SEAT	P. 26
2883749-458	FRONT HIGH COVERAGE BUMPER	P. 28
2884189-458	REAR HIGH COVERAGE BUMPER	P. 28
2889208-458	HD EXTREME KICK-OUT ROCK SLIDERS, 2-SEAT	P. 29

2883752	LOCK & RIDE 40 L REAR CARGO BOX	P. 32
2889784	7.25 L DOOR STORAGE BAG	P. 33
2889404-458	PIVOTING SPARE TIRE CARRIER	P. 33
2883758	POLARIS PRO HD 2,041 kg WINCH	P. 35

Shown on Pro XP 2-Seat.

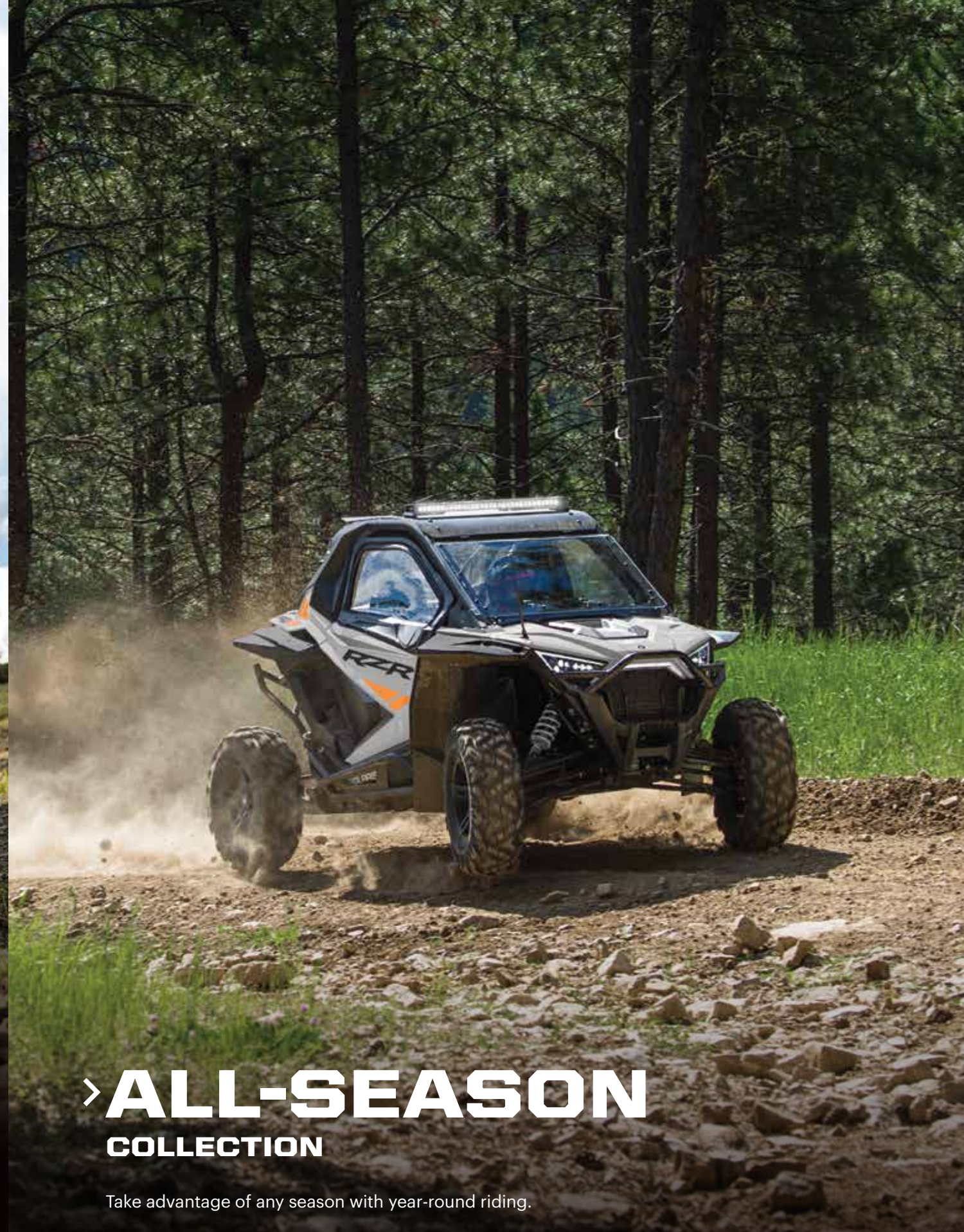

> ALL-SEASON COLLECTION

Take advantage of any season with year-round riding.

2889536	TIP OUT WINDSHIELD - HARD COAT POLY	P. 25
2883757	LOCK & RIDE POLY REAR PANEL, 2-SEAT	P. 25
2883743-458	ALUMINUM ROOF, 2-SEAT	P. 26
2884664	UPPER DOORS, 2-SEAT	P. 27
2884658	FRONT DOOR INNER CLOSEOFF PANELS	P. 27

2883749-458	FRONT HIGH COVERAGE BUMPER	P. 28
2884189-458	REAR HIGH COVERAGE BUMPER	P. 28
2884685	FULL COVERAGE FENDER FLARES	P. 28
2884386	HEATER KIT	P. 27

Shown on Pro XP 2-Seat.



Rockford Fosgate partnered with Polaris to create the next evolution of factory-installed off road audio. Purpose-built to stand up to any outdoor environment and designed to perform no matter the ride. Specifically tuned and rider-centric to create an audio experience that is second to none.

- PLUG & PLAY
- ELEMENT READY
- NO LOSS OF CARGO SPACE
- BLUETOOTH

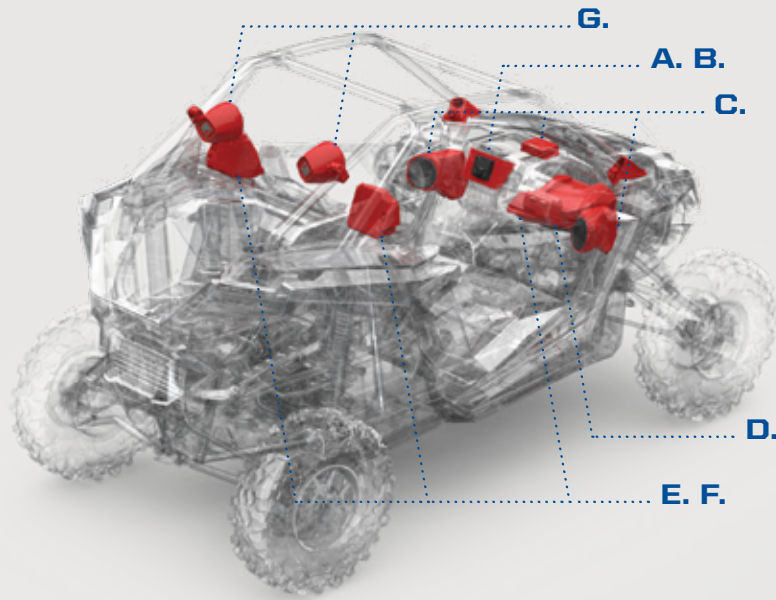

SOURCE UNITS

AMPLIFIERS

SPEAKERS

SUBWOOFERS

- Designed specifically for the Pro platform
- Tuned to combat wind and motor noise, delivering an incredible sound no matter the speed
- Element ready design guards against dust and moisture intrusion

- Ultra Compact CLEAN technology
- Highly efficient design capable of being pushed hard without overheating

- Off road Optimized Element Ready speakers thrive in any outdoor environment
- Specifically tuned enclosures create rich cockpit sound
- Rugged, yet lightweight, materials that don't sacrifice speed for sound

- High-power, high-excursion subwoofer that acoustically couples with the cockpit for perfect bass response
- Torture tested to ensure long life and performance



A. 7" DISPLAY POWERED BY RIDE COMMAND*

» 2884072
PRO R 4 '22-23, PRO R '22-23, TURBO R 4 '22-23, TURBO R '22-23, PRO XP 4 '20-23, PRO XP '20-23
REQUIRES MOUNT KIT 2884584
STANDARD ON PREMIUM/ULTIMATE MODELS
SEE P. 82 FOR FULL RIDE COMMAND DETAILS



B. PMX-P2 HEAD UNIT

- 6.86 cm full color display
- AM/FM/WB tuner* & Pandora control
- Bluetooth connectivity
- Includes mount kit

» 2884256
PRO R 4 '22-23, PRO R '22-23, TURBO R 4 '22-23, TURBO R '22-23, PRO XP 4 '20-23, PRO XP '20-23
NOT COMPATIBLE WITH PREMIUM/ULTIMATE MODELS



C. STAGE 2 ^{TOP SELLER} FULL RANGE AMPLIFIER AND FRONT UNDER-DASH SPEAKERS

- 400 watt full range amplifier
- 50 watt 16.51 cm component speakers including tweeters with enclosures

» 2883943
PRO R 4 '22-23, PRO R '22-23, TURBO R 4 '22-23, TURBO R '22-23, PRO XP 4 '20-23, PRO XP '20-23
STANDARD ON PREMIUM/ULTIMATE MODELS



D. STAGE 3 25.4 cm POWERED SUBWOOFER UPGRADE

- 400 watt 25.4 cm subwoofer with enclosure and grille
- 400 watt integrated subwoofer amplifier

» 2883857
PRO R 4 '22-23, PRO R '22-23, TURBO R 4 '22-23, TURBO R '22-23, PRO XP 4 '20-23, PRO XP '20-23



E. STAGE 4 25.4 cm POWERED SUBWOOFER WITH REAR COAXIAL SPEAKER UPGRADE

- 400 watt 25.4 cm subwoofer with enclosure and grille
- 400 watt integrated subwoofer amplifier
- 50 watt 16.51 cm coaxial speakers with enclosures and grilles

» 2884655
PRO R 4 '22-23, PRO R '22-23, TURBO R 4 '22-23, TURBO R '22-23, PRO XP 4 '20-23, PRO XP '20-23



F. STAGE 5 30 cm POWERED SUBWOOFER WITH FULL SYSTEM SPEAKER UPGRADE

- 400 watt 30 cm subwoofer with enclosure and grille
- 400 watt integrated subwoofer amplifier
- 100 watt 16.51 cm coaxial speakers with enclosures and stainless steel grilles
- 100 watt 16.51 cm front component replacement speakers
- High output tweeters with stainless steel grilles
- 2x more power and sound delivery over the stock system

» 2889463
PRO R 4 '22-23, PRO R '22-23, TURBO R 4 '22-23, TURBO R '22-23, PRO XP 4 '20-23, PRO XP '20-23
COMPATIBLE WITH PREMIUM/ULTIMATE MODELS ONLY. PREMIUM MODELS REQUIRE 2884904, SOLD SEPARATELY.
NOT COMPATIBLE WITH REAR PODS (2883945). SUBWOOFER ADDITION ELIMINATES GLOVE BOX STORAGE



G. REAR PODS USE WITH STAGE 2, STAGE 3 OR STAGE 4

- 50 watt 16.51 cm coaxial speakers with can-enclosures, mounting hardware and grilles

» 2883945
PRO R 4 '22-23, PRO R '22-23, TURBO R 4 '22-23, TURBO R '22-23, PRO XP 4 '20-23, PRO XP '20-23
NOT COMPATIBLE WITH ROCKFORD FOSGATE ULTIMATE LE MODELS OR STAGE 5 AUDIO UPGRADE (2889463)

BUILD YOUR SOUND
(CHOOSE THE PATH THAT MATCHES YOUR RZR)

FACTORY-INSTALLED

SKIP TO STEP 3



PRO R, TURBO R & PRO XP PREMIUM

- | | |
|----------------------------------|---|
| 2-SEAT
PMX-P2
+
STAGE 1 | 4-SEAT
PMX-P2
+
STAGE 1 AND
REAR SPEAKERS |
|----------------------------------|---|



PRO R, TURBO R & PRO XP ULTIMATE

- | | |
|--|---|
| 2-SEAT
RIDE COMMAND
+
STAGE 2 | 4-SEAT
RIDE COMMAND
+
STAGE 2 AND
REAR SPEAKERS |
|--|---|

NO FACTORY AUDIO

STEP 1

SELECT HEAD UNIT

PMX-P2 HEAD UNIT

2884256
PRO R 4 '22-23, PRO R '22-23, TURBO R 4 '22-23, TURBO R '22-23, PRO XP 4 '20-23, PRO XP '20-23

NOT COMPATIBLE WITH ULTIMATE MODELS

MOUNT KIT INCLUDED

7" DISPLAY WITH RIDE COMMAND*

2884072
PRO R 4 '22-23, PRO R '22-23, TURBO R 4 '22-23, TURBO R '22-23, PRO XP 4 '20-23, PRO XP '20-23

MOUNT KIT REQUIRED

2884584
PRO R 4 '22-23, PRO R '22-23, TURBO R 4 '22-23, TURBO R '22-23, PRO XP 4 '20-23, PRO XP '20-23
SEE P. 82 FOR FULL RIDE COMMAND DETAILS

STEP 2

ADD AUDIO KIT

STAGE 2

FULL RANGE AMPLIFIER AND FRONT UNDER-DASH SPEAKERS

2883943
PRO R 4 '22-23, PRO R '22-23, TURBO R 4 '22-23, TURBO R '22-23, PRO XP 4 '20-23, PRO XP '20-23
STANDARD ON ULTIMATE MODELS

STEP 3

UPGRADE AUDIO

PRO R, TURBO R & PRO XP PREMIUM AMP UPGRADE KIT

2884908
PRO R 4 '22-23, PRO R '22-23, TURBO R 4 '22-23, TURBO R '22-23, PRO XP 4 '20-23, PRO XP '20-23
PREMIUM MODELS ONLY
REQUIRED FOR ANY PREMIUM UPGRADE TO STAGE 3-5



STAGE 3 25.4 cm POWERED SUBWOOFER UPGRADE

2883857
PRO R 4 '22-23, PRO R '22-23, TURBO R 4 '22-23, TURBO R '22-23, PRO XP 4 '20-23, PRO XP '20-23
NOT COMPATIBLE WITH STAGE 4



STAGE 4 25.4 cm POWERED SUBWOOFER WITH REAR COAXIAL SPEAKER UPGRADE

2884655
PRO R 4 '22-23, PRO R '22-23, TURBO R 4 '22-23, TURBO R '22-23, PRO XP 4 '20-23, PRO XP '20-23
NOT COMPATIBLE WITH STAGE 3
ALL 4-SEAT MODELS WITH FACTORY AUDIO INCLUDE REAR SPEAKERS



STAGE 5 30 cm POWERED SUBWOOFER WITH FULL SYSTEM SPEAKER UPGRADE

2889463
PRO R 4 '22-23, PRO R '22-23, TURBO R 4 '22-23, TURBO R '22-23, PRO XP 4 '20-23, PRO XP '20-23
PREMIUM/ULTIMATE MODELS ONLY
NOT COMPATIBLE WITH REAR PODS (2883945), STAGE 3 OR STAGE 4

+ / OR

REAR PODS

2883945
PRO R 4 '22-23, PRO R '22-23, TURBO R 4 '22-23, TURBO R '22-23, PRO XP 4 '20-23, PRO XP '20-23
NOT COMPATIBLE WITH ROCKFORD FOSGATE ULTIMATE LE MODELS, STAGE 5 AUDIO UPGRADE (2889463)
ADD TO STAGES 2-4

*Due to ongoing supply chain issues, there may be delayed or limited availability of this product as an accessory add-on.



NEW AUDIO ROOF 20 cm SPEAKERS, 25.4 cm SUBWOOFER, 83.8 cm PRO ARMOR LIGHT BAR

- 800 watt
- 25.4 cm subwoofer
- 83.8 cm Pro Armor Single-Row Light Bar
- RGB accent lights
- LED dome light (2-Seat: 1, 4-Seat: 2)



PMX-P2 (Head unit included)

- » 2-SEAT • 2889710
TURBO R '22-23, PRO XP '20-23
- » 4-SEAT • 2889708
TURBO R 4 '22-23, PRO XP 4 '20-23

NOT COMPATIBLE WITH REAR PODS (2883945) OR STAGES 2-5.
SECONDARY BATTERY KIT REQUIRED (2884347/2884391), SOLD SEPARATELY.

VEHICLE-INTEGRATED AUDIO

- » 2-SEAT • 2889711
TURBO R '22-23, PRO XP '20-23
- » 4-SEAT • 2889709
TURBO R 4 '22-23, PRO XP 4 '20-23

NOT RECOMMENDED WITH STAGE 5. SECONDARY BATTERY KIT REQUIRED (2884347/2884391), SOLD SEPARATELY.

> BUILD YOUR CAB

ADD COMFORT AND STYLE WITH END-TO-END PROTECTION



ADD A ROOF
Shield from harsh elements while adding style.

ADD A REAR PANEL
Maintain rear visibility while reducing rear air swirl.

ADD A WINDSHIELD
Protect all riders with optical clarity.

ADD DOORS
Keep the cab free of debris and water.



LOCK & RIDE

REVOLUTIONARY INSTALLATION

Lock & Ride clamps make for easy on-off and eliminate the risk of cracking.

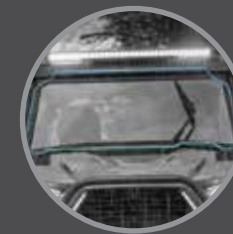

GASKETED SEAL

Keeps drafts and moisture out. Reduces ride chatter on full glass windshields.

WINDSHIELDS

GLASS



FULL VENTED WINDSHIELD - GLASS TOP SELLER

• Double-layer, laminated and tempered glass windshield with steel, powder-coated frame and adjustable center vent

- » **TURBO R** **PRO XP** 2889019
TURBO R 4 '22-23, TURBO R '22-23, PRO XP 4 '20-23, PRO XP '20-23
NOT COMPATIBLE WITH LIGHT POCKET ALUMINUM ROOF (2883961, 2883991)
- » **PRO R** 2-SEAT • 2884350
PRO R '22-23
- » **PRO R** 4-SEAT • 2884823
PRO R 4 '22-23



GLASS WINDSHIELD WIPER KIT

• Simple to control with a multi-speed, dash-mounted switch
• Includes a washer fluid reservoir

- » 2890145
TURBO R 4 '22-23, TURBO R '22-23, PRO XP 4 '20-23, PRO XP '20-23
COMPATIBLE WITH GLASS WINDSHIELD ONLY

HARD COAT POLY



LOCK & RIDE
FULL VENTED WINDSHIELD - HARD COAT POLY

• Impact-resistant, long-lasting .64 cm durable hard coated polycarbonate
• Full protection with airflow vents that quickly open for cockpit ventilation

- » **TURBO R** **PRO XP** 2884305
TURBO R 4 '22-23, TURBO R '22-23, PRO XP 4 '20-23, PRO XP '20-23
COMPATIBLE WITH ALUMINUM ROOF ONLY (2883961, 2883743, 2883991, 2883990)
- » **TURBO R** **PRO XP** 2883756
TURBO R 4 '22-23, TURBO R '22-23, PRO XP 4 '20-23, PRO XP '20-23
COMPATIBLE WITH POLY SPORT ROOF ONLY (2883928, 2883946)
- » **PRO R** 2-SEAT • 2884968
PRO R '22-23
- » **PRO R** 4-SEAT • 2884747
PRO R 4 '22-23



LOCK & RIDE
HALF WINDSHIELD - HARD COAT POLY, MID

• Impact-resistant, long-lasting .64 cm durable hard coated polycarbonate
• Provides both protection and airflow into the cab
• 30.48 cm tall

- » 2884966
PRO R 4 '22-23, PRO R '22-23, TURBO R 4 '22-23, TURBO R '22-23, PRO XP 4 '20-23, PRO XP '20-23



TIP OUT WINDSHIELD - HARD COAT POLY

• Hard coated polycarbonate panel windshield with closed, vented and fully open positions
• Dual-handled latches with gas support struts

- » **TURBO R** **PRO XP** 2889536
TURBO R 4 '22-23, TURBO R '22-23, PRO XP 4 '20-23, PRO XP '20-23
NOT COMPATIBLE WITH LIGHT POCKET ALUMINUM ROOF (2883961, 2883991)



LOCK & RIDE
HALF WINDSHIELD - HARD COAT POLY, LOW

• Provides added protection from the elements, while allowing optimum airflow and visibility
• 12.7 cm tall

- » 2884746
PRO R 4 '22-23, PRO R '22-23, TURBO R 4 '22-23, TURBO R '22-23, PRO XP 4 '20-23, PRO XP '20-23

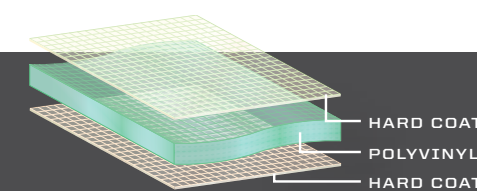
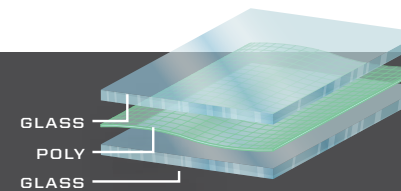

GLASS VS HARD COAT POLY

- Superior optical clarity (automotive level)
- Scratch-resistant
- Seals tight
- Cold weather/heavy duty

- Lightweight, flexible, easy to store/remove
- Impact-resistant
- 30x more scratch resistance than regular poly windshields

REAR PANEL

LOCK & RIDE
POLY REAR PANEL

• Drape formed 3mm polycarbonate for lightweight, impact-resistant durability
• Maintains rear visibility and reduces rear air swirl from entering the cockpit
• If installed, Rear Audio Pods should project backwards

TURBO R	PRO XP	4-SEAT	NOT SHOWN
2-SEAT		2884147	
2883757			
TURBO R '22-23, PRO XP '20-23		TURBO R 4 '22-23, PRO XP 4 '20-23	
PRO R		4-SEAT	NOT SHOWN
2-SEAT	NOT SHOWN	2884594	
2884352			
PRO R '22-23		PRO R 4 '22-23	

TURBO R PRO XP
RECOMMENDED 2-SEAT CAB

2889019	FULL VENTED WINDSHIELD - GLASS
2890145	GLASS WINDSHIELD WIPER KIT
2883757	POLY REAR PANEL
2883928	POLY SPORT ROOF
2884664	UPPER DOORS
2884658	FRONT DOOR INNER CLOSEOFF PANELS

TURBO R PRO XP
RECOMMENDED 4-SEAT CAB

2884305	FULL VENTED WINDSHIELD - HARD COAT POLY
2884147	POLY REAR PANEL
2883990-458	ALUMINUM ROOF
2884660-458	ALUMINUM DOORS
2884665	UPPER DOORS

Available on 2-Seat and 4-Seat vehicles.

Available on 2-Seat and 4-Seat vehicles.

> ROOFS

POLY

POLY SPORT ROOF

- Durable, lightweight polypropylene with contoured design for water run-off
- Maximum protection with full seal for a leak-free barrier and reduced chatter

TURBO R	PRO XP		
COLOR	2-SEAT	4-SEAT	NOT SHOWN
■ MATTE BLACK	2883928	2883946	
	TURBO R '22-23, PRO XP '20-23	TURBO R 4 '22-23, PRO XP 4 '20-23	

ALUMINUM

VS

POLY

- High protection strength
- Lower profile
- Sleek style

- Water run-off
- Pre-existing mounting features
- Lightweight

ALUMINUM

ALUMINUM ROOF

- .32 cm lightweight aluminum stamped sheet with full seal for a leak-free barrier and vibration elimination
- Quick install, low-profile design with maximum protection and durability from the harshest conditions

TURBO R	PRO XP		
COLOR	2-SEAT	4-SEAT	NOT SHOWN
■ MATTE BLACK	2883743-458	2883990-458	
■ INDY RED	2883743-293	2883990-293	
	TURBO R '22-23, PRO XP '20-23	TURBO R 4 '22-23, PRO XP 4 '20-23	MATTE BLACK STOCK ON TURBO R 4/TURBO R PREMIUM/ULTIMATE

PRO R		
COLOR	2-SEAT	4-SEAT
■ MATTE BLACK	2884237-458	2884325-458

LIGHT POCKET ALUMINUM ROOF

- .32 cm lightweight aluminum stamped sheet with full seal for a leak-free barrier and vibration elimination
- Low-profile with light pocket
- Quick installation with maximum protection and durability from the harshest conditions
- Not compatible with Full Vented Windshield - Glass (2889109) or Tip Out Windshield - Hard Coat Poly (2889536)

TURBO R	PRO XP		
COLOR	2-SEAT	4-SEAT	NOT SHOWN
■ MATTE BLACK	2883961-458	2883991-458	
	TURBO R '22-23, PRO XP '20-23	TURBO R 4 '22-23, PRO XP 4 '20-23	

ADD THE 71.12 cm RIGID SINGLE ROW LED LIGHT BAR, WHICH FITS PERFECTLY INTO THE ROOF POCKET. SEE P. 30 FOR MORE DETAILS



VISIONARY DESIGN

Relentless attention to detail delivers extraordinary style and function for the ultimate ride.



> DOORS

DOOR CLOSEOFFS

- Lightweight plastic door closeoffs provide riders protection from mud, rocks and water
- Quick installation and seamless fit into door opening
- Retains front ventilation

▶ 2883765
PRO R '22-23, TURBO R '22-23, PRO XP '20-23
STANDARD ON 4-SEAT, PREMIUM/ULTIMATE MODELS

ALUMINUM DOORS

- 12-gauge thick, stamped aluminum with full lower coverage and seal to keep out water, mud, dust and debris
- Uses factory door frames, with 4-Seat option providing an additional seal between front and rear doors
- Compatible with Front Door Inner Closeoff Panels (2884658, 2884831) and Upper Doors (2884664, 2884665)

COLOR	2-SEAT	NOT SHOWN	4-SEAT
■ MATTE BLACK	2884659-458		2884660-458
	PRO R '22-23, TURBO R '22-23, PRO XP '20-23		PRO R 4 '22-23, TURBO R 4 '22-23, PRO XP 4 '20-23
			NOT COMPATIBLE WITH LOW PROFILE ROCK SLIDERS (2883987)

FRONT DOOR INNER CLOSEOFF PANELS

- Vacuum formed polyethylene with full lower coverage and seal that keeps out water, mud, dust and debris
- Built-in armrest
- 2-Seat option maintains color accent boomerang
- Compatible with Door Closeoffs (2883765) and Aluminum Doors (2884659-458, 2884660-458)

▶ 2-SEAT • 2884658
PRO R '22-23, TURBO R '22-23, PRO XP '20-23
NOT COMPATIBLE WITH ROCK SLIDERS (2883760, 2883997)

▶ 4-SEAT • 2884831 (NOT SHOWN)
PRO R 4 '22-23, TURBO R 4 '22-23, PRO XP 4 '20-23
NOT COMPATIBLE WITH ROCK SLIDERS (2883987, 2883988)

UPPER DOORS

- High quality compression molded doors nest into thermoformed high-density polyethylene side shrouds for excellent sealing
- Includes zip-down 30-gauge clear vinyl windows
- Provides profiled cab edge for superior fit and finish
- Includes seals for key closeoff areas

▶ TURBO R PRO XP 2-SEAT • 2884664
TURBO R '22-23, PRO XP '20-23

▶ TURBO R PRO XP 4-SEAT • 2884665 (NOT SHOWN)
TURBO R 4 '22-23, PRO XP 4 '20-23

SOME DRIVERS MAY EXPERIENCE PASSENGER SIDE MIRROR OBSTRUCTION WHEN USED WITH UPPER DOORS. USE WITH CAUTION.

> HEATER

HEATER KIT

- Connects to Polaris PULSE bus bar to provide reliable, steady heat to your cab with fan speed and temperature control
- Closeable driver and passenger floor vents and electronic demist vent shutoff

▶ PRO XP 2884386
PRO XP 4 '20-23, PRO XP '20-23

CHOOSE YOUR DOOR

ADD DOOR ACCESSORIES

PRO R, TURBO R & PRO XP

AUDIO

WINDSHIELDS & REAR PANELS

ROOFS, DOORS & HEATER

VEHICLE PROTECTION

LIGHTING

STORAGE

MISC, MIRRORS & WINCHES

> BUMPERS / FENDER FLARES

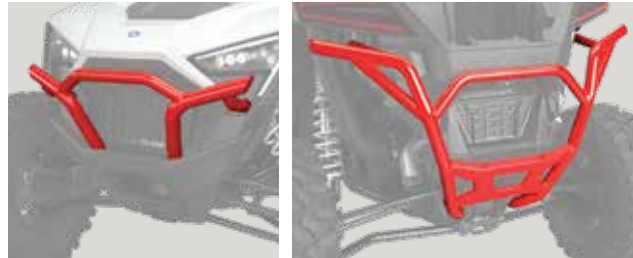

LOW PROFILE BUMPER

• Durable, powder-coated 3.8 cm - 4.5 cm tube steel with sleek lower profile

COLOR	PRO XP	
	FRONT	REAR
MATTE BLACK	2883746-458	2883748-458
INDY RED	2883746-293	2883748-293
BLUE METALLIC	2883746-751	NA

PRO XP 4 '20-23, PRO XP '20-23
TURBO R 4 '22-23, TURBO R '22-23, PRO XP 4 '20-23, PRO XP '20-23
BUMPER BRACKET (2889566) REQUIRED FOR FRONT LOW PROFILE BUMPER (2883746-XXX) WHEN USED ON PRO XP/PRO XP 4 SPORT '22-23



HIGH COVERAGE BUMPER

• Durable 12-gauge, powder-coated steel with extended high-coverage design for maximum vehicle protection

COLOR	PRO XP	
	FRONT	REAR
MATTE BLACK	2883749-458	2884189-458
INDY RED	2883749-293	2884189-293

PRO XP 4 '20-23, PRO XP '20-23
TURBO R 4 '22-23, TURBO R '22-23, PRO XP 4 '20-23, PRO XP '20-23



HIGH COVERAGE BUMPER

• Durable 10-gauge, powder-coated 4.5 cm tube steel
• Compatible with winch or 6" light bar, both sold separately

COLOR	PRO R		TURBO R		PRO R	
	FRONT	REAR	FRONT	REAR	FRONT	REAR
MATTE BLACK	2884353-458	2884356-458	2884353-458	2884356-458	2884353-458	2884356-458

PRO R 4 '22-23, PRO R '22-23, TURBO R 4 '22-23, TURBO R '22-23
PRO R 4 '22-23, PRO R '22-23



PRE RUNNER BUMPER

• Durable, powder-coated 3.8 cm steel tube

COLOR	PRO R		TURBO R		PRO R	
	FRONT	REAR	FRONT	REAR	FRONT	REAR
MATTE BLACK	2884354-458	2884358-458	2884354-458	2884358-458	2884354-458	2884358-458
INDY RED	2884354-293	2884358-293	2884354-293	2884358-293	2884354-293	2884358-293

PRO R 4 '22-23, PRO R '22-23, TURBO R 4 '22-23, TURBO R '22-23
PRO R 4 '22-23, PRO R '22-23



PRE RUNNER WINCH BUMPER

• Durable, powder-coated 3.8 cm steel tube
• Requires winch (2884340, 2884341), sold separately

COLOR	PRO R		TURBO R	
	FRONT	REAR	FRONT	REAR
MATTE BLACK	2884355-458	2884359-458	2884355-458	2884359-458
INDY RED	2884355-293	2884359-293	2884355-293	2884359-293

PRO R 4 '22-23, PRO R '22-23, TURBO R 4 '22-23, TURBO R '22-23
PRO R 4 '22-23, PRO R '22-23



PRE RUNNER BUMPER

• Durable, powder-coated 1.5" steel tube

COLOR	PRO XP	
	FRONT	REAR
MATTE BLACK	2884581-458	2884585-458

PRO XP 4 '20-23, PRO XP '20-23
TURBO R 4 '22-23, TURBO R '22-23, PRO XP 4 '20-23, PRO XP '20-23

INTEGRATED WINCH
SEE P. 35

RIGID 15.24 cm LIGHT BAR
SEE P. 30

Next-level style and function. Front bumpers are designed to effortlessly integrate a winch or 15.2 cm RIGID light bar.



FULL COVERAGE FENDER FLARES

• Covers the rear body opening to prevent mud from flying into the vehicle
• Maximum protection with 15.2 cm of additional coverage and extended, removable mud flaps
• Front and rear included

» 2884685
PRO R 4 '22-23, PRO R '22-23, TURBO R 4 '22-23, TURBO R '22-23, PRO XP 4 '20-23, PRO XP '20-23

> ROCK SLIDERS

12-GAUGE STAMPED STEEL
NO LOSS IN GROUND CLEARANCE

LOW PROFILE

COLOR	2-SEAT		4-SEAT	
	MATTE BLACK	2883760-458	2883987-458	2883760-458
INDY RED	2883760-293	2883987-293	2883760-293	2883987-293

PRO R '22-23, TURBO R '22-23, PRO XP '20-23
PRO R 4 '22-23, TURBO R 4 '22-23, PRO XP 4 '20-23, PRO XP '20-23

4.5CM STEEL TUBE CONSTRUCTION WITH 70% THICKER WALLS, EXTENDS FROM MACHINE FOR MAX PROTECTION THROUGH ROUGH TERRAIN

HD EXTREME KICK-OUT

COLOR	2-SEAT		4-SEAT	
	MATTE BLACK	2889208-458	2889209-458	2889208-458
INDY RED	2889208-293	2889209-293	2889208-293	2889209-293

PRO R '22-23, TURBO R '22-23, PRO XP '20-23
PRO R 4 '22-23, TURBO R 4 '22-23, PRO XP 4 '20-23, PRO XP '20-23

SEAMLESS INSTALLATION
Reusable anchors allow for easy installation of rock sliders into the built-in, dedicated chassis location.



ALL ROCK SLIDERS: ONLY COMPATIBLE WITH ALUMINUM DOORS (2884660-458, 2884659-458) WHEN DOOR SEAL IS REMOVED. NOT COMPATIBLE WITH FRONT DOOR INNER CLOSEOFF PANELS (2884658, 2884831)

PRO R, TURBO R & PRO XP

AUDIO

WINDSHIELDS & REAR PANELS

ROOFS, DOORS & HEATER

VEHICLE PROTECTION

LIGHTING

STORAGE

MISC. MIRRORS & WINCHES

> LIGHTING



ADVANCED TECH

RIGID® lights are driven by Aluminum PCB Smart Boards™, 6063-T5 aircraft aluminum extruded housings and Tiger Drylac® UV protection polyester powdercoating.

EXCLUSIVE OPTICS

RIGID® invests heavily in optical science and has patented multiple optics and optics systems, maximizing light output and efficiency.

LIGHT BAR OPTIONS

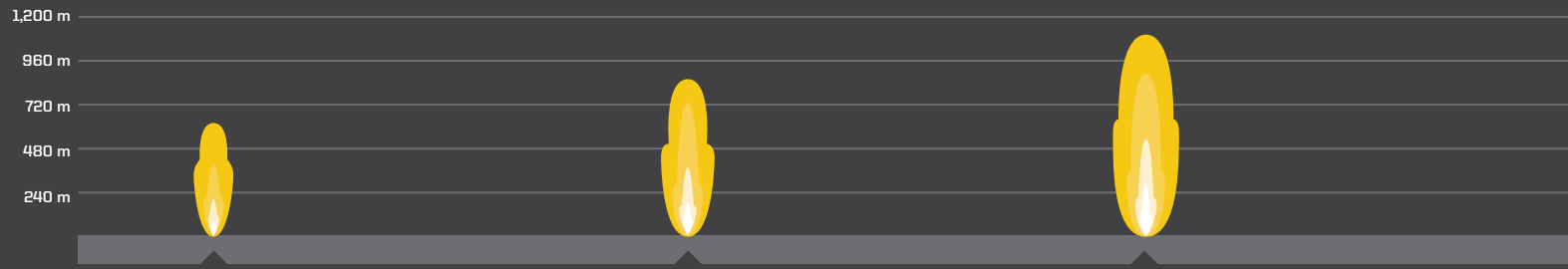

BRAND SIZE TYPE
RIGID 15.2 cm DUAL-ROW E-SERIES
RAW LUMENS 9,504
PN 2884649
FITMENT PRO R 4 '22-23, PRO R '22-23, TURBO R 4 '22-23, TURBO R '22-23, PRO XP 4 '20-23, PRO XP '20-23

MOUNTS IN WINCH POCKET FOR SEAMLESS INTEGRATION IN FRONT BUMPERS

TURBO R PRO XP
RIGID 71.1 cm SR-SERIES
RAW LUMENS 17,556
PN 2884074
FITMENT TURBO R 4 '22-23, TURBO R '22-23, PRO XP 4 '20-23, PRO XP '20-23

DESIGNED FOR USE WITH LIGHT POCKET ALUMINUM ROOF

RIGID 81.3 cm SR-SERIES
RAW LUMENS 20,064
PN 2884648
FITMENT PRO R 4 '22-23, PRO R '22-23, TURBO R 4 '22-23, TURBO R '22-23, PRO XP 4 '20-23, PRO XP '20-23

MOUNTS TO ROOF FOR MAXIMUM VISIBILITY



RIGID CHASE LIGHT

- Bright, daylight visible lighting with eleven selectable modes, including white scene lighting for accessing cargo bed in the dark
- Connects into brake light system for additional high mount brake light

» 2884359



ACCENT LIGHT

- Durable construction resists dust and water while on the trails
- Front fascia LED accent light

» 2884346

PRO R 4 '22-23, PRO R '22-23, TURBO R 4 '22-23, TURBO R '22-23, PRO XP 4 '20-23, PRO XP '20-23 STANDARD ON PREMIUM/ULTIMATE MODELS

POLARIS ENGINEERED ADVANTAGES



PLUG & PLAY ELECTRICAL

POLARIS PULSE IS A REVOLUTIONARY way to provide power to your vehicle and makes adding electrical accessories a snap.

1. CHOOSE YOUR LIGHT BAR

2. ADD A MOUNT

3. ADD A HARNESS

MOUNT OPTIONS

15.2 cm LIGHT BAR MOUNT
PRO XP » 2884654
PRO R TURBO R » 2884595
 PRO XP 4 '20-23, PRO XP '20-23
 PRO R 4 '22-23, PRO R '22-23, TURBO R 4 '22-23, TURBO R '22-23

71.1 cm LIGHT
TURBO R PRO XP
MOUNT INCLUDED WITH LIGHT
 PRO R 4 '22-23, PRO R '22-23, TURBO R 4 '22-23, TURBO R '22-23

81.3 cm LIGHT BAR MOUNT
TURBO R PRO XP » 2884650
PRO R » 2884601
 TURBO R 4 '22-23, TURBO R '22-23, PRO XP 4 '20-23, PRO XP '20-23
 PRO R 4 '22-23, PRO R '22-23

CHASE LIGHT MOUNT KIT
 » 2884896
 PRO R 4 '22-23, PRO R '22-23, TURBO R 4 '22-23, TURBO R '22-23, PRO XP 4 '20-23, PRO XP '20-23

HARNESS OPTIONS

MODEL	LIGHT BAR SET-UPS		CHASE LIGHT
	1 LIGHT IN 1 LOCATION ON 1 SWITCH	2 LIGHTS IN 2 LOCATIONS ON 2 SWITCHES	
PRO R / 4 '22-23 TURBO R / 4 '22-23 PRO XP / 4 '20-23	POLARIS PULSE LIGHT BAR HARNESS 2883949 POLARIS PULSE HD LIGHT BAR HARNESS 2889130 FOR LIGHTS THAT DRAW OVER 10A	POLARIS PULSE LIGHT BAR HARNESS (x2) 2883949 POLARIS PULSE HD LIGHT BAR HARNESS (x2) 2889130 FOR LIGHTS THAT DRAW OVER 10A	CHASE LIGHT HARNESS 2889034



SEE FULL LIGHTING OPTIONS P.80

PRO R, TURBO R & PRO XP

AUDIO

WINDSHIELDS & REAR PANELS

ROOFS, DOORS & HEATER

VEHICLE PROTECTION

LIGHTING

STORAGE

MISC. MIRRORS & WINCHES



HAVE IT ALL

> STORAGE

	TURBO R	PRO XP	PRO R
28 L NORTHSTAR COOLER - GRAPHITE			2883424
LOCK & RIDE 28 L NORTHSTAR COOLER BRACKET	2884070		2889200
LOCK & RIDE REAR CARGO BOX	2883752		2884236
PIVOTING SPARE TIRE CARRIER	2889404-458		2884326-458
7.25 L DOOR STORAGE BAG			2889784
9.5 L SHOULDER STORAGE BAG			2889785

LOCK & RIDE
FORWARD CARGO BOX

- TOP SELLER**
- Easy-to-use latches and molded side handles
 - Durable polypropylene, engineered to seal out dust and water
 - Lock & Ride strongly secures the box to the cargo bed
- » **TURBO R** **PRO XP**
69 L • 2883751
TURBO R 4 '22-23, TURBO R '22-23, PRO XP 4 '20-23, PRO XP '20-23
- » **PRO R**
57 L • 2884235
PRO R 4 '22-23, PRO R '22-23



FIT:
2 Full-Size Helmets
Tool Kit
Jacket/Coat
Food & Drinks

LOCK & RIDE
REAR CARGO BOX

- Easy-to-use latches and molded side handles
 - Durable polypropylene, engineered to seal out dust and water
 - Lock & Ride strongly secures the box to the cargo bed
- » **TURBO R** **PRO XP**
40 L • 2883752
TURBO R 4 '22-23, TURBO R '22-23, PRO XP 4 '20-23, PRO XP '20-23
- » **PRO R**
34 L • 2884236
PRO R 4 '22-23, PRO R '22-23



FIT:
Sleeping Bag
First Aid Kit
Snacks
Sunscreen

FORWARD CARGO AND REAR CARGO STORAGE BOXES NEST PERFECTLY TOGETHER

REAR CARGO STORAGE BOX AND 28 L NORTHSTAR COOLER NEST PERFECTLY TOGETHER

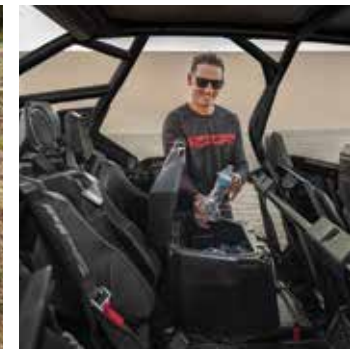
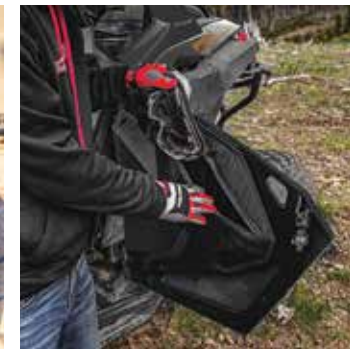

LOCK & RIDE
72 L MULTI-PASSENGER REAR SEAT CARGO BOX

- Single wall base and dual wall lid that seal out dust and water
 - Lock & Ride mounting for easy installation and removal
 - Includes a drain plug and mounting hardware, with a location to add a padlock for increased security
 - Only compatible with flip forward/fold flat storage in Premium/Ultimate models
 - Fits full size off road vehicle helmet
- » 2884666
PRO R 4 '22-23, TURBO R 4 '22-23, PRO XP 4 '20-23



PIVOTING SPARE TIRE CARRIER

- Secure mounting with dual latches
 - Steel mounts and rack
 - Holds up to a 33" tire and supports 34 kg of weight
 - Single-handed release mechanism
- » **TURBO R** **PRO XP** 2889404-458
TURBO R 4 '22-23, TURBO R '22-23, PRO XP 4 '20-23, PRO XP '20-23
- » **PRO R** 2884326-458
PRO R 4 '22-23, PRO R '22-23

LOCK & RIDE
28 L REAR COOLER

- Lid locks securely in place with rubber latches to protect cargo
 - Provides plenty of storage without weighing you down
 - Keeps your food, beverages and bait fresh while out on the trails
 - Nests with forward cargo box
- » 2889740
PRO R 4 '22-23, PRO R '22-23, TURBO R 4 '22-23, TURBO R '22-23, PRO XP 4 '20-23, PRO XP '20-23



POLARIS NORTHSTAR 28 L COOLER

- Nests with rear cargo box
- » GRAPHITE • 2883424
» DESERT • 2881315
PRO R 4 '22-23, PRO R '22-23, TURBO R 4 '22-23, TURBO R '22-23, PRO XP 4 '20-23, PRO XP '20-23



LOCK & RIDE
NORTHSTAR 28 L COOLER BRACKET

- » **TURBO R** **PRO XP** 2884070
TURBO R 4 '22-23, TURBO R '22-23, PRO XP 4 '20-23, PRO XP '20-23
- » **PRO R** 2889200
PRO R 4 '22-23, PRO R '22-23
NOT COMPATIBLE WITH SPARE TIRE CARRIER

SEE P. 100 FOR FULL DETAILS ON POLARIS NORTHSTAR COOLERS

9.5 L SHOULDER STORAGE BAG

- Keeps your belongings safe and secure
 - Molded sides, lid inserts, waterproof zipper and a nylon mesh pocket for versatile storage options
 - Easy install and quick access with a sleek cockpit look
- » 2889785
PRO R 4 '22-23, PRO R '22-23, TURBO R 4 '22-23, TURBO R '22-23, PRO XP 4 '20-23, PRO XP '20-23
FITS BETWEEN REAR SEATS ON 4-SEAT MODELS



FIT:
Flashlight
Snacks
Sunglasses
Bug Spray

7.25 L DOOR STORAGE BAG

- Quick reach access to keep supplies and gear secure
 - Waterproof zipper keeps everything enclosed, clean and dry
 - Molded face with EVA carbon fiber vinyl cover design
- » 2889784
PRO R 4 '22-23, PRO R '22-23, TURBO R 4 '22-23, TURBO R '22-23, PRO XP 4 '20-23, PRO XP '20-23
COMPATIBLE WITH FRONT DOORS ONLY
NOT COMPATIBLE WITH FRONT DOOR INNER CLOSEOFF PANELS (2884658, 2884831)



FIT:
Cell Phone
Gloves
Sunscreen

SEE COVERS AND STRAPS P. 118



> MISC

S6B PARTICLE SEPARATOR

- Separates over 94% of dust before it reaches the air filter
- Integrated hidden design in the fender to stay out of sight
- Variable fan based on engine speed to keep noise levels low

» **PRO XP** 2884629
PRO XP 4 '20-23, PRO XP '20-23

ORDERABLE THROUGH LOCAL DEALER ONLY



> MIRRORS

ADJUSTABLE FOLDING SIDE MIRRORS

- Installs in minutes and integrates into a designated mounting position
- Laminated safety glass for excellent scratch resistance

» 2883762

PRO R 4 '22-23, PRO R '22-23, TURBO R 4 '22-23, TURBO R '22-23, PRO XP 4 '20-23, PRO XP '20-23



PREMIUM CONVEX REARVIEW MIRROR TOP SELLER

- Installs in minutes and integrates into a designated mounting position
- Laminated safety glass for excellent scratch resistance

» 2883763

PRO R 4 '22-23, PRO R '22-23, TURBO R 4 '22-23, TURBO R '22-23, PRO XP 4 '20-23, PRO XP '20-23



SECONDARY BATTERY MOUNT KIT

- Provides longer lasting 12V output
- Battery sold separately

» 2884347

PRO R '22-23, TURBO R '22-23, PRO XP '20-23
STANDARD ON PRO R 4/PRO R PREMIUM/ULTIMATE MODELS

» 2884391

PRO R 4 '22-23, TURBO R 4 '22-23, PRO XP 4 '20-23
STANDARD ON PRO R 4/PRO R PREMIUM/ULTIMATE MODELS



> WINCHES



FEATURES	PRO PRO HEAVY DUTY SERIES	
RAPID ROPE RECOVERY	STANDARD	
AUTO STOP TECHNOLOGY	STANDARD	
WINCH LINE	SYNTHETIC ROPE	
CONTROL	WIRELESS & WIRED STANDARD	
MODEL	2,721 kg	2,041 kg
PRO R / TURBO R PRO R 4 / PRO R '22-23 TURBO R 4 / TURBO R '22-23 INCLUDES BOTH WIRED AND WIRELESS REMOTE	2884341	2884340
PRO XP PRO XP 4 / PRO XP '20-23 INCLUDES BOTH WIRED AND WIRELESS REMOTE	2883759	2883758

REPLACEMENT PARTS

- 15 M SYNTHETIC ROPE
- 2,721 kg SERIES » 2879188
- 2,041 kg SERIES » 2879187

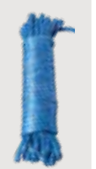

SEE ADDITIONAL WINCH INFORMATION P.104

INTRODUCING THE NEW

POLARIS RZR XP

BEST-SELLING PERFORMANCE SIDE-BY-SIDE

RIGID CHASE LIGHT
SEE P. 50

> TERRAIN VERSATILITY

Developed to take on various landscapes, so you can confidently get anywhere.

PROTECTION P. 48
RIGID LIGHTING P. 50
PRO ARMOR WHEELS & TIRES P. 84

> ELEVATED CRAFTSMANSHIP

Intentional styling that puts quality and compatibility first.

REAR PANELS P. 45
UPPER DOORS P. 47
STORAGE P. 52
COOLERS P. 100

> NEXT-LEVEL INTEGRATION

Designed alongside the vehicle, to allow for seamless installation on your ride.

ROCKFORD FOSGATE AUDIO P. 42
WINDSHIELDS P. 45
ROOFS P. 46
WINCHES P. 55



TRAIL COLLECTION

Navigate the trails through forests, hills and plains.



MUD COLLECTION

Power through the deepest ruts and wear the mud as a badge of honor.

2884542	LOCK & RIDE FULL VENTED WINDSHIELD - HARD COAT POLY	P. 45
2884519	LOCK & RIDE POLY REAR PANEL	P. 45
2884513-293	FRONT HIGH COVERAGE BUMPER	P. 48
2884514-293	REAR HIGH COVERAGE BUMPER	P. 48
2884512-293	HD EXTREME KICK-OUT ROCK SLIDERS, 4-SEAT	P. 49
2889133	FULL COVERAGE FENDER FLARES	P. 49
2883763	PREMIUM CONVEX REARVIEW MIRROR	P. 54
2884524	ADJUSTABLE FOLDING SIDE MIRRORS	P. 54
2884562	STAGE 4 AUDIO UPGRADE BY ROCKFORD FOSGATE*	P. 42
2884648	RIGID* SR-SERIES 81.3 cm COMBO LED LIGHT BAR	P. 50
2884650	81.3 cm LIGHT BAR MOUNT	P. 50
2889291	POLARIS PULSE LIGHT BAR HARNESS	P. 50
2884359	RIGID* CHASE LIGHT	P. 50

2889121	CHASE LIGHT MOUNT KIT	P. 50
2889293	CHASE LIGHT HARNESS KIT	P. 50
2884649	RIGID* E-SERIES 15.2 cm LIGHT BAR	P. 50
2884510	15.2 cm LIGHT BAR MOUNT	P. 50
2884530	8 L SHOULDER STORAGE BAG	P. 52
2884528	4.7 L DOOR STORAGE BAG	P. 52
2884548	TONNEAU COVER	P. 53
2884546-458	PIVOTING SPARE TIRE CARRIER	P. 53
2884836	POLARIS PRO HD 2,041 KG WINCH	P. 55
2889555	PRO ARMOR WHEEL & TIRE SET: 4302 BEADLOCK & CRAWLER XG, 30"	P. 99
5415616	PRO ARMOR SPARE TIRE: CRAWLER XG, 30"	P. 91
5418036	PRO ARMOR SPARE WHEEL: 4302 BEADLOCK, 14"	P. 97

Shown on XP 4-Seat.

2884539	LOCK & RIDE HALF WINDSHIELD - HARD COAT POLY	P. 45
2884513-458	FRONT HIGH COVERAGE BUMPER	P. 48
2884514-458	REAR HIGH COVERAGE BUMPER	P. 48
2889133	FULL COVERAGE FENDER FLARES	P. 49
2883763	PREMIUM CONVEX REARVIEW MIRROR	P. 54
2884561	STAGE 2 AUDIO UPGRADE BY ROCKFORD FOSGATE*	P. 42
2889292	STAGE 3 AUDIO UPGRADE BY ROCKFORD FOSGATE**	P. 42
2884562	STAGE 4 AUDIO UPGRADE BY ROCKFORD FOSGATE*	P. 42
2883945	REAR SPEAKER PODS BY ROCKFORD FOSGATE*	P. 42
2884648	RIGID* SR-SERIES 81.3 cm COMBO LED LIGHT BAR	P. 50

2884650	81.3 cm LIGHT BAR MOUNT	P. 50
2889291	POLARIS PULSE LIGHT BAR HARNESS	P. 50
2884525	LOCK & RIDE 52 L REAR CARGO BOX	P. 52
2881315	POLARIS NORTHSTAR 28 L COOLER	P. 53
2884526	LOCK & RIDE NORTHSTAR 28 L COOLER BRACKET	P. 53
2884530	8 L SHOULDER STORAGE BAG	P. 52
2884528	4.7 L DOOR STORAGE BAG	P. 52
2884836	POLARIS PRO HD 2,041 KG WINCH	P. 55
2890165	PRO ARMOR WHEEL & TIRE SET: 5305 BEADLOCK & MUD XC, 30"	P. 98

Shown on XP 2-Seat.

*Stage 3 Audio Upgrade comes stock on Ultimate models.



> BACKCOUNTRY COLLECTION

Get off the beaten path and make the ride part of the adventure.



> ALL-SEASON COLLECTION

Take advantage of any season with year-round riding.

2884542	LOCK & RIDE FULL VENTED WINDSHIELD - HARD COAT POLY	P. 45
2884549-293	ALUMINUM ROOF, 2-SEAT	P. 46
2884472-293	LOW PROFILE ROCK SLIDER, 2-SEAT	P. 49
2883763	PREMIUM CONVEX REARVIEW MIRROR	P. 54
2884524	ADJUSTABLE FOLDING SIDE MIRRORS	P. 54
2889614	STAGE 5 AUDIO UPGRADE BY ROCKFORD FOSGATE*	P. 42
2884648	RIGID® SR-SERIES 81.3 cm COMBO LED LIGHT BAR	P. 50
2884650	81.3 cm LIGHT BAR MOUNT	P. 50

2889291	POLARIS PULSE LIGHT BAR HARNESS	P. 50
2884359	RIGID® CHASE LIGHT	P. 50
2889121	CHASE LIGHT MOUNT KIT	P. 50
2889293	CHASE LIGHT HARNESS KIT	P. 50
2889611	LOCK & RIDE 78 L FORWARD CARGO BOX	P. 52
2889612	LOCK & RIDE 28 L REAR COOLER	P. 53
2884530	8 L SHOULDER STORAGE BAG	P. 52
2885030	PRO ARMOR WHEEL & TIRE SET: 5204 & PRO RUNNER, 30"	P. 98

Shown on XP 2-Seat.

2884545	FULL VENTED WINDSHIELD - GLASS	P. 45
2884579	WINDSHIELD WIPER - WASHER KIT	P. 45
2884519	LOCK & RIDE POLY REAR PANEL	P. 45
2884554	POLY SPORT ROOF, 4-SEAT*	P. 46
2884534	UPPER DOORS, 4-SEAT	P. 47
2884513-458	FRONT HIGH COVERAGE BUMPER	P. 48
2884514-458	REAR HIGH COVERAGE BUMPER	P. 48
2884512-458	HD EXTREME KICK-OUT ROCK SLIDERS, 4-SEAT	P. 49
2889133	FULL COVERAGE FENDER FLARES	P. 49

Shown on XP 4-Seat.

2883763	PREMIUM CONVEX REARVIEW MIRROR	P. 54
2884524	ADJUSTABLE FOLDING SIDE MIRRORS	P. 54
2884523	HEATER KIT	P. 47
2885003	STAGE 1 AUDIO KIT BY ROCKFORD FOSGATE***	P. 42
2884528	4.7 L DOOR STORAGE BAG	P. 52
2884548	TONNEAU COVER	P. 53
2884835	POLARIS HD 2,041 KG WINCH	P. 55
2883166	PRO ARMOR WHEEL & TIRE SET: 5202 & ATTACK 2.0, 30"	P. 98

*Poly Sport Roof comes stock on Premium/Ultimate models.
 **Stage 1 Audio Kit comes stock on Premium models; not compatible with Ultimate models.



Rockford Fosgate partnered with Polaris to create the next evolution of factory-installed off road audio. Purpose-built to stand up to any outdoor environment and designed to perform no matter the ride. Specifically tuned and rider-centric to create an audio experience that is second to none.



PLUG & PLAY



ELEMENT READY



NO LOSS OF CARGO SPACE



BLUETOOTH

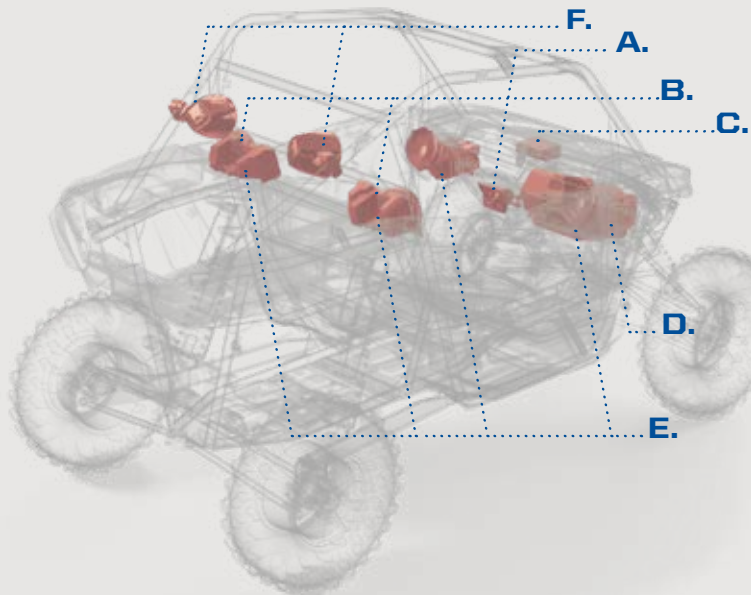

SOURCE UNITS

- Tuned to combat wind and motor noise, delivering an incredible sound no matter the speed
- Element ready design guards against dust and moisture intrusion

AMPLIFIERS

- Ultra compact CLEAN technology
- Highly efficient design capable of being pushed hard without overheating

SPEAKERS

- Off road optimized Element Ready speakers thrive in any outdoor environment
- Specifically tuned enclosures create rich cockpit sound
- Rugged, yet lightweight, materials that don't sacrifice speed for sound

SUBWOOFERS

- High-power, high-excursion subwoofer that acoustically couples with the cockpit for perfect bass response
- Torture tested to ensure long life and performance



**A. STAGE 1
PMX-P2 HEAD UNIT &
16.51 cm DASH SPEAKERS**

- 6.86 cm full color display
- AM/FM/WB tuner*, Pandora control, Bluetooth connectivity
- Includes mount kit
- **50 watt** 16.51 cm coaxial speakers with enclosures

» 2885003
XP 4 '24, XP '24
STANDARD ON PREMIUM MODELS
NOT COMPATIBLE WITH ULTIMATE MODELS



**B. STAGE 2
16.51 cm REAR SPEAKERS**

- **50 watt** 16.51 cm component speakers including tweeters with enclosures

» 2884561
XP 4 '24, XP '24
STANDARD ON ULTIMATE MODELS



**C. STAGE 3
AMPLIFIER UPGRADE KIT**

- **400 watt** full range amplifier

» 2889292
XP 4 '24, XP '24
STANDARD ON ULTIMATE MODELS



**D. STAGE 4
25.4 cm POWERED SUBWOOFER**

- 25.4 cm subwoofer with enclosure and grille
- **400 watt** integrated subwoofer amplifier

» 2884562
XP 4 '24, XP '24
STAGE 3 AUDIO (2889292) REQUIRED, SOLD SEPARATELY
NOT COMPATIBLE WITH STAGE 5 AUDIO



**E. STAGE 5
30 cm POWERED SUBWOOFER WITH
FULL SYSTEM SPEAKER UPGRADE**

- **400 watt** 30 cm subwoofer with enclosure and grille
- **100 watt** dash speakers (x2)
- **100 watt** rear speakers with enclosures and stainless steel grilles
- 2x more power and sound delivery over the stock system

» 2889614
XP 4 '24, XP '24
STAGE 3 AUDIO (2889292) REQUIRED, SOLD SEPARATELY
NOT COMPATIBLE WITH STAGE 4 AUDIO OR REAR PODS



**F. REAR PODS
USE WITH STAGES 1-4**

- **50 watt** 16.51 cm coaxial speakers with can-enclosures, mounting hardware and grilles

» 2883945
XP 4 '24, XP '24
NOT COMPATIBLE WITH STAGE 5 AUDIO UPGRADE (2889614)



BUILD YOUR SOUND
(CHOOSE THE PATH THAT MATCHES YOUR RZR)

FACTORY-INSTALLED

SKIP TO STEP 2



XP
PREMIUM

PMX-P2 + STAGE 1



XP
ULTIMATE

RIDE COMMAND + STAGE 3

NO FACTORY AUDIO

STEP 1

ADD BASE AUDIO

**STAGE 1
PMX-P2 HEAD UNIT &
16.51 cm DASH SPEAKERS**

2885003
XP 4 '24, XP '24
STANDARD ON PREMIUM MODELS
NOT COMPATIBLE WITH ULTIMATE MODELS

STEP 2

UPGRADE AUDIO

**STAGE 2
16.51 cm REAR SPEAKERS**

2884561
XP 4 '24, XP '24
STANDARD ON ULTIMATE MODELS

+ / OR

**STAGE 3
AMPLIFIER UPGRADE KIT**

2889292
XP 4 '24, XP '24
STANDARD ON ULTIMATE MODELS

+ / OR

REAR PODS

2883945
XP 4 '24, XP '24
NOT COMPATIBLE WITH STAGE 5 AUDIO UPGRADE (2889614)
ADD TO STAGES 1-4

STEP 3

CRANK THE BASS

**STAGE 4
25.4 cm POWERED
SUBWOOFER**

2884562
XP 4 '24, XP '24
STAGE 3 AUDIO (2889292) REQUIRED, SOLD SEPARATELY
NOT COMPATIBLE WITH STAGE 5 AUDIO

OR

**STAGE 5
30 cm POWERED SUBWOOFER WITH
FULL SYSTEM SPEAKER UPGRADE**

2889614
XP 4 '24, XP '24
STAGE 3 AUDIO (2889292) REQUIRED, SOLD SEPARATELY
NOT COMPATIBLE WITH STAGE 4 AUDIO OR REAR PODS

> BUILD YOUR CAB

ADD COMFORT AND STYLE WITH END-TO-END PROTECTION

ADD A WINDSHIELD
Protect all riders with optical clarity.

ADD A ROOF
Shield from harsh elements while adding style.

ADD A REAR PANEL
Maintain rear visibility while reducing rear air swirl.

ADD UPPER DOORS
Keep the cab free of debris and water.



PROFILE ROPS
Provides a flat sealing surface for the glass windshield gasket and indentation along the A-pillar for optimized fit.



DASH GROOVE
Dedicated nesting location along the dash for windshields to rest, creating a tighter seal to eliminate air gaps.

WINDSHIELDS GLASS



FULL VENTED WINDSHIELD - GLASS

- Double-layer, laminated and tempered glass windshield with steel, powder-coated frame and adjustable center vents
 - ECE R43 certified
- » 2884545
XP 4 '24, XP '24



GLASS WINDSHIELD WIPER KIT

- Simple to control with a multi-function, dash-mounted switch
 - Includes a washer fluid reservoir
- » 2884579
XP 4 '24, XP '24
COMPATIBLE WITH GLASS WINDSHIELD ONLY



HARD COAT POLY

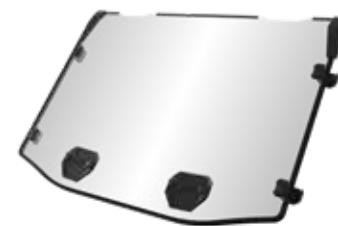

LOCK & RIDE FULL VENTED WINDSHIELD - HARD COAT POLY

- Impact-resistant, long-lasting .64 cm durable hard coated polycarbonate
 - Full protection with airflow vents that quickly open for cockpit ventilation
- » 2884542
XP 4 '24, XP '24



LOCK & RIDE FULL WINDSHIELD - HARD COAT POLY

- Impact-resistant, long-lasting .64 cm durable hard coated polycarbonate
 - No frame design offers maximum visibility
 - Integrates with all cab components
- » 2884540
XP 4 '24, XP '24



LOCK & RIDE HALF WINDSHIELD - HARD COAT POLY

- Provides added protection from the elements, while allowing optimum airflow and visibility
 - 18 cm tall
- » 2884539
XP 4 '24, XP '24

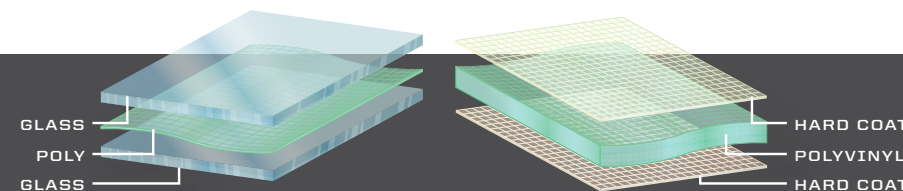

GLASS VS HARD COAT POLY

- | | |
|--|--|
| <ul style="list-style-type: none"> • Superior optical clarity (automotive level) • Scratch-resistant • Seals tight • Cold weather/heavy duty | <ul style="list-style-type: none"> • Lightweight, flexible, easy to store/remove • Impact-resistant • 30x more scratch resistance than regular poly windshields |
|--|--|

REAR PANEL



LOCK & RIDE POLY REAR PANEL

- Designed with a flat polycarbonate viewing area to maintain rearward visibility
- A thermoformed shroud seals the lower portion of the cab to reduce rear air swirl
- Compatible with all storage and the spare tire carrier

» 2884519
XP 4 '24, XP '24
NOT COMPATIBLE WITH REAR SPEAKER PODS (2883945)

RECOMMENDED 2-SEAT CAB

2884545	FULL VENTED WINDSHIELD - GLASS
2884579	GLASS WINDSHIELD WIPER KIT
2884519	POLY REAR PANEL
2884553	POLY SPORT ROOF
2884533	UPPER DOORS
2889402	EXTERIOR DOOR LATCH

Available on 2-Seat and 4-Seat vehicles.

RECOMMENDED 4-SEAT CAB

2884545	FULL VENTED WINDSHIELD - GLASS
2884579	GLASS WINDSHIELD WIPER KIT
2884519	POLY REAR PANEL
2884551-458	ALUMINUM ROOF
2884534	UPPER DOORS
2889402	EXTERIOR DOOR LATCH
2889403	EXTERIOR DOOR LATCH (REAR)

Available on 2-Seat and 4-Seat vehicles.



> ROOFS

> DOORS

POLY

POLY SPORT ROOF

- Durable, lightweight polypropylene with contoured design for water run-off
- Maximum protection with full seal for a leak-free barrier and reduced chatter

COLOR	2-SEAT	4-SEAT <small>[NOT SHOWN]</small>
MATTE BLACK	2884553 XP '24	2884554 XP 4 '24

ALUMINUM VS POLY

- | | |
|--|--|
| <ul style="list-style-type: none"> • High protection strength • Lower profile • Sleek style | <ul style="list-style-type: none"> • Water run-off • Pre-existing mounting features • Lightweight |
|--|--|



ALUMINUM

ALUMINUM ROOF

- .32 cm lightweight aluminum stamped sheet with full seal for a leak-free barrier and vibration elimination
- Quick install, low-profile design with maximum protection and durability from the harshest conditions

COLOR	2-SEAT	4-SEAT <small>[NOT SHOWN]</small>
MATTE BLACK	2884549-458 XP '24	2884551-458 XP 4 '24
INDY RED	2884549-293 XP '24	2884551-293 XP 4 '24



UPPER DOORS

- High quality compression molded doors nest into thermoformed high-density polyethylene side shrouds for excellent sealing
- Includes zip-down 30-gauge clear vinyl windows
- Provides profiled cab edge for superior fit and finish
- Includes external latches

COLOR	2-SEAT	4-SEAT <small>[NOT SHOWN]</small>
MATTE BLACK	2884533 XP '24	2884534 XP 4 '24

EXTERIOR DOOR LATCH

- Makes opening doors from outside the vehicle easier
- Includes one set of front or rear latches

- » FRONT • 2889402
XP 4 '24, XP '24
- » REAR • 2889403 [NOT SHOWN]
XP 4 '24

> HEATER

HEATER KIT

- Connects to Polaris PULSE bus bar and provides reliable, steady heat to your cab with fan speed and temperature control
- Select between in-cab heat, demist vents or both with a controllable knob

- » 2884523
XP 4 '24, XP '24



> VEHICLE PROTECTION

BUMPERS



LOW PROFILE BUMPER

- Durable, powder-coated 3.8 cm tube steel with sleek lower profile

COLOR	FRONT	REAR
MATTE BLACK	2884472-458 XP 4 '24, XP '24	2884516-458 XP 4 '24, XP '24

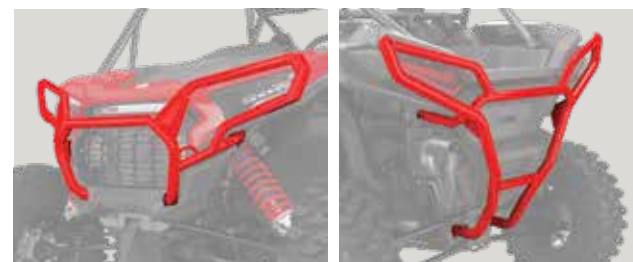

HIGH COVERAGE BUMPER

- Durable 3.8 cm tube steel with headlight bezels for maximum coverage

COLOR	FRONT	REAR
MATTE BLACK	2884513-458	2884514-458
INDY RED	2884513-293 XP 4 '24, XP '24	2884514-293 XP 4 '24, XP '24

ROCK SLIDERS



12-GAUGE STAMPED STEEL
NO LOSS IN GROUND CLEARANCE

LOW PROFILE

COLOR	2-SEAT	4-SEAT
MATTE BLACK	2884472-458	2884511-458
INDY RED	2884472-293 XP '24	2884511-293 XP 4 '24

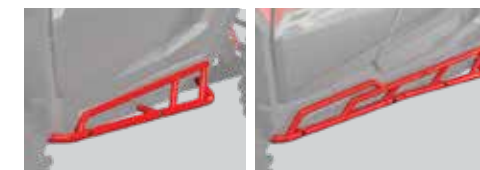

3.18 CM STEEL TUBE CONSTRUCTION FOR
MAX PROTECTION THROUGH ROUGH TERRAIN

HD EXTREME KICK-OUT

COLOR	2-SEAT	4-SEAT
MATTE BLACK	2884473-458	2884512-458
INDY RED	2884473-293 XP '24	2884512-293 XP 4 '24

SEAMLESS INSTALLATION
Reusable anchors allow for easy installation of rock sliders into the built-in, dedicated chassis location.



CLOSED/UNLOCKED



OPEN/LOCKED

NEXT-LEVEL STYLE AND FUNCTION. FRONT BUMPERS ARE DESIGNED TO EFFORTLESSLY INTEGRATE A WINCH OR 15.2 CM RIGID LIGHT BAR



INTEGRATED WINCH
SEE P. 55



RIGID 15.24 CM LIGHT BAR
SEE P. 50

FENDER FLARES & ARM GUARDS



FULL COVERAGE FENDER FLARES

- Replaces stock fender flares and provides additional coverage with factory styling
- Front and rear included

2889133
XP 4 '24, XP '24
STANDARD ON TRACTOR AND ZUG VERSION



TRAILING ARM GUARDS

- Reliable protection for vital suspension components of your vehicle
- HDPE poly guard bolts to Trailing Arm Guards to protect against rock abrasions

2889442
XP 4 '24, XP '24

> LIGHTING



ADVANCED TECH

RIGID® lights are driven by Aluminum PCB Smart Boards™, 6063-T5 aircraft aluminum extruded housings and Tiger Drylac® UV protection polyester powdercoating.

EXCLUSIVE OPTICS

RIGID® invests heavily in optical science and has patented multiple optics and optics systems, maximizing light output and efficiency.

POLARIS ENGINEERED ADVANTAGES

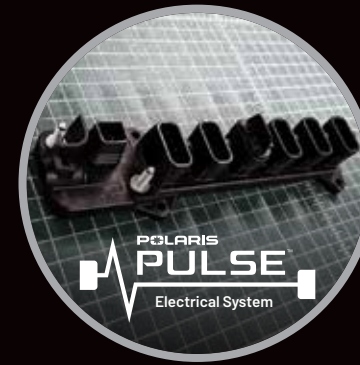

PLUG & PLAY ELECTRICAL

POLARIS PULSE IS A REVOLUTIONARY way to provide power to your vehicle and makes adding electrical accessories a snap.



1. CHOOSE YOUR LIGHT BAR

LIGHT BAR OPTIONS

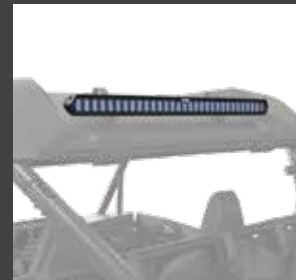
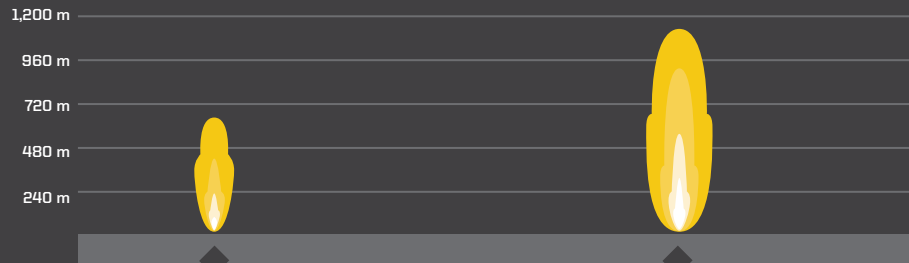

BRAND TYPE	RIGID DUAL-ROW E-SERIES
RAW LUMENS	9,504
PN	2884649
FITMENT	XP 4 '24, XP '24 REQUIRES BUMPER, SOLD SEPARATELY.



MOUNTS TO FRONT FASCIA
WITH ACCESSORY BUMPER

BRAND TYPE	RIGID SR-SERIES
RAW LUMENS	20,064
PN	2884648
FITMENT	XP 4 '24, XP '24 REQUIRES ROOF, SOLD SEPARATELY.



MOUNTS TO ROOF
FOR MAXIMUM VISIBILITY

RIGID CHASE LIGHT

- Bright, daylight visible lighting with eleven selectable modes, including white scene lighting for accessing cargo bed in the dark
 - Connects into brake light system for additional high mount brake light
- » 2884359
XP 4 '24, XP '24



ACCENT LIGHT KIT

- Durable construction resists dust and water while on the trails
 - Front and rear LED accent lights
- » 2889539
XP 4 '24, XP '24
STANDARD ON ULTIMATE MODELS

2. ADD A MOUNT

MOUNT OPTIONS

15.2 cm LIGHT BAR MOUNT

» 2884510
XP 4 '24, XP '24

81.3 cm LIGHT BAR MOUNT

» 2884650
XP 4 '24, XP '24

CHASE LIGHT MOUNT KIT

» 2889121
XP 4 '24, XP '24

3. ADD A HARNESS

HARNESS OPTIONS

MODEL	LIGHT BAR SET-UPS		CHASE LIGHT
	1 LIGHT IN 1 LOCATION ON 1 SWITCH	2 LIGHTS IN 2 LOCATIONS ON 2 SWITCHES	
XP 4 / XP	POLARIS PULSE LIGHT BAR HARNESS 2889291	POLARIS PULSE LIGHT BAR HARNESS (x2) 2889291	CHASE LIGHT HARNESS 2889293



SEE FULL LIGHTING OPTIONS P.80



XP
AUDIO
WINDSHIELDS & REAR PANELS
ROOFS, DOORS & HEATERS
VEHICLE PROTECTION
LIGHTING
STORAGE
MIRRORS & WINCHES
2014-2023 XP 1000, XP TURBO & TURBO S

> STORAGE

LOCK & RIDE
78 L FORWARD CARGO BOX

- Easy-to-use latches and molded side handles
- Durable polypropylene, engineered to seal out dust and water
- Lock & Ride strongly secures the box to the cargo bed

» 2889611
XP 4 '24, XP '24



Fit: 2 Full-Size Helmets | Tool Kit | Jacket/Coat | Food & Drinks

FORWARD CARGO BOX NESTS PERFECTLY TOGETHER WITH REAR CARGO BOX OR 28 L REAR COOLER

LOCK & RIDE
52 L REAR CARGO BOX

- Easy-to-use latches and molded side handles
- Durable polypropylene, engineered to seal out dust and water
- Lock & Ride strongly secures the box to the cargo bed

» 2884525
XP 4 '24, XP '24



Fit: Jacket/Coat | First Aid Kit | Snacks | Sunscreen

REAR CARGO BOX NESTS PERFECTLY TOGETHER WITH 28 L NORTHSTAR COOLER OR FORWARD CARGO BOX

LOCK & RIDE
28 L REAR COOLER

- Lid locks securely in place with rubber latches to protect cargo
- Provides plenty of storage without weighing you down
- Keeps your food, beverages and bait fresh while out on the trails
- Nests with forward cargo box

» 2889612
XP 4 '24, XP '24



POLARIS NORTHSTAR COOLER

POLARIS NORTHSTAR 28 L COOLER

- Nests with rear cargo box

» GRAPHITE • 2883424
» DESERT • 2881315
XP 4 '24, XP '24

LOCK & RIDE
NORTHSTAR 28 L COOLER BRACKET

» 2884526
XP 4 '24, XP '24



SEE P. 100 FOR FULL DETAILS ON POLARIS NORTHSTAR COOLERS

Fit: Flashlight | Snacks | Sunglasses | Bug Spray

8 L SHOULDER STORAGE BAG

- Keeps your belongings safe and secure
- Molded sides and lid with dual YKK® zippers
- Easy install and quick access with a sleek cockpit look

» 2884530
XP 4 '24, XP '24
FITS BETWEEN REAR SEATS ON 4-SEAT MODELS



Fit: Cell Phone | Gloves | Sunscreen

4.7 L DOOR STORAGE BAG

- Quick reach access to keep supplies and gear secure
- Waterproof YKK® zippers keep everything enclosed, clean and dry

» 2884528
XP 4 '24, XP '24
COMPATIBLE WITH FRONT DOORS ONLY



TONNEAU COVER

- One cover seals the entire storage box
- Built-in friction hinge to stay open on its own

» 2884548
XP 4 '24, XP '24
NOT COMPATIBLE WITH CARGO BOXES OR COOLERS



PIVOTING SPARE TIRE CARRIER

- Secure mounting with dual latches and single-handed release mechanism
- Steel mounts and rack
- Holds up to a 32" tire and supports 34 kg of weight

» 2884546-458
XP 4 '24, XP '24



SEE COVERS AND STRAPS P. 118



> MIRRORS



ADJUSTABLE FOLDING SIDE MIRRORS

- Left and right mirrors included
- Installs in minutes and integrates into a designed mounting position
- Laminated safety glass for excellent scratch resistance

» 2884524
XP 4 '24, XP '24



PREMIUM CONVEX REARVIEW MIRROR TOP SELLER

- Installs in minutes and integrates into a designated mounting position
- Laminated safety glass for excellent scratch resistance

» 2883763
XP 4 '24, XP '24



> WINCHES



FEATURES	PRO PRO HEAVY DUTY SERIES	HD HEAVY DUTY SERIES
RAPID ROPE RECOVERY	STANDARD	NOT AVAILABLE
AUTO STOP TECHNOLOGY	STANDARD	OPTION
WINCH LINE	SYNTHETIC ROPE	STEEL CABLE
CONTROL	WIRED TOGGLE SWITCH & WIRELESS REMOTE STANDARD	WIRED TOGGLE SWITCH STANDARD, WIRELESS REMOTE OPTIONAL
MODEL	2,041 kg	2,041 kg
XP 4 / XP '24	2884836	2884835

REPLACEMENT PARTS

15 M SYNTHETIC ROPE

2,041 kg SERIES
» 2879187



AUTO STOP UPGRADE

• Replaces stock fairlead
» 2889028
SYNTHETIC ROPE & WIRELESS REMOTE (2889561), REQUIRED

UPGRADE YOUR HD WINCH

WIRED REMOTE CONTROL

• 1.8 m corded remote
• Direct plug & play operation
» 2889562



WIRELESS REMOTE

• Up to 15 m range with LED indicator
• Direct plug & play operation
» 2889561



SEE ADDITIONAL WINCH INFORMATION P.104



> WINDSHIELDS

HARD COAT POLY



LOCK & RIDE

FULL VENTED WINDSHIELD - HARD COAT POLY

- Impact-resistant, long-lasting .64 cm durable hard coated polycarbonate
- Full protection with airflow vents that quickly open for cockpit ventilation

» 2884330

XP TURBO '19-21, XP 4 TURBO '19-21, XP 4 1000 '19-23, XP 1000 '19-23



LOCK & RIDE

FULL WINDSHIELD - HARD COAT POLY TOP SELLER

- Durable, optical-grade polycarbonate provides maximum impact resistance

» 2884018

XP TURBO '19-21, XP 4 TURBO '19-21, XP 4 1000 '19-23, XP 1000 '19-23



LOCK & RIDE

HALF WINDSHIELD - HARD COAT POLY

- Impact-resistant, long-lasting .64 cm durable hard coated polycarbonate

- Provides protection and airflow into the cab
- 17.8 cm tall

» 2884768

TURBO S '18-21, XP TURBO '19-21, TURBO S 4 '19-21, XP 4 TURBO '19-21, XP 4 1000 '19-23, XP 1000 '19-23

GLASS



FULL WINDSHIELD - GLASS

- Double layer laminated, tempered glass windshield

- Fits seamlessly with the roof and hood of your vehicle to form a complete seal for maximum durability and reduced chatter

» 2884331

XP TURBO '19-21, XP 4 TURBO '19-21, XP 4 1000 '19-23, XP 1000 '19-23

> REAR PANELS & DOORS



LOCK & RIDE

POLY REAR PANEL TOP SELLER

» 2881614

XP TURBO '15-21, XP 4 TURBO '16-21, XP 4 1000 '14-23, XP 1000 '14-23
NOT COMPATIBLE WITH EXTREME AUDIO PODS (2883739)



LOWER DOOR INSERTS TOP SELLER

- Covers the bottom of the door opening, shutting out water and dust
- Durable plastic construction with steel frame

» 2-SEAT • 2879509 NOT SHOWN

TURBO S '18-21, XP TURBO '15-21, XP 1000 '14-23

» 4-SEAT • 2879942

TURBO S 4 '19-21, XP 4 TURBO '16-21, XP 4 1000 '14-23



CANVAS UPPER DOORS

- Easy install with stock door panels using pre-designated mounting points
- 23 OZ mold-resistant, UV-stable and crack-resistant materials for lasting durability and protection from the elements

- Install with roof, full windshield, rear panel and lower doors to create a full cab enclosure for colder weather and/or increased protection from the elements

- Not compatible with Poly Sport Roof or Audio Roof options

» 2-SEAT • 2884333

XP TURBO '19-21, XP 1000 '19-23

» 4-SEAT • 2884332 NOT SHOWN

XP 4 TURBO '19-21, XP 4 1000 '19-23

> ROOFS



LOCK & RIDE

POLY SPORT ROOF TOP SELLER

- Rigid, injection-molded design to eliminate warping in high-heat conditions
- Integrated mounting locations for lighting
- Rugged, textured polyethylene construction for impact and abrasion resistance
- Not compatible with upper or full doors

COLOR	2-SEAT	4-SEAT	NOT SHOWN
MATTE BLACK	2883073	2883074	
	XP TURBO '15-21, XP 1000 '14-23	XP 4 TURBO '16-21, XP 4 1000 '14-23	



GRAPHIC SPORT ROOF

- Weighs only 5 kg (30% lighter than aluminum)
- Won't bend or break upon impact with debris or other obstacles
- Sunroof lets in sunlight while shading from the heat

COLOR	2-SEAT
MATTE BLACK	2881206
INDY RED	2881607
	XP TURBO '15-21, XP 1000 '14-23

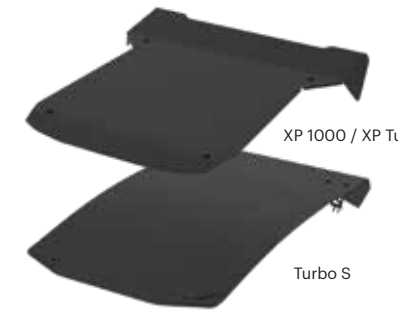

ALUMINUM ROOF TOP SELLER

- Seals to the vehicle frame for the best protection and great integration with other RZR accessories
- Strong and durable 5051 aluminum construction for long-lasting, reliable protection

COLOR	2-SEAT	4-SEAT	NOT SHOWN
MATTE BLACK	2881582-458	2881592-458	
INDY RED	NA	2881592-293	
	XP TURBO '15-21, XP 1000 '14-23	XP 4 TURBO '16-21, XP 4 1000 '14-23	
MATTE BLACK	2884086-458	2884087-458	
	TURBO S '18-21	TURBO S 4 '19-21	
	COMES STOCK ON TURBO S AND TURBO S 4 DYNAMIX		

> VEHICLE PROTECTION

LOW PROFILE BUMPER TOP SELLER

- Perfect for heavy-duty protection, with aggressive style and mounting for lights



FRONT

4.4 cm DIAMETER STEEL TUBE CONSTRUCTION



REAR

COLOR	FRONT	REAR
MATTE BLACK	2884019-458	2884020-458
INDY RED	2884019-293	2884020-293
	XP TURBO '15-21, XP 4 TURBO '16-21, XP 4 1000 '14-23, XP 1000 '14-23	

COLOR	2-SEAT	4-SEAT
MATTE BLACK	2883132-458	2883133-458
	TURBO S '18-21, TURBO S 4 '19-21	

LOW PROFILE ROCK SLIDERS

- Plated steel construction, durable powdercoat finish
- Easy installation with expanded anchor mount

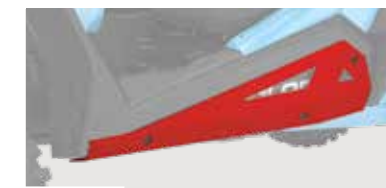

2-SEAT

LOW PROFILE: NO LOSS IN GROUND CLEARANCE



4-SEAT

COLOR	2-SEAT	4-SEAT
MATTE BLACK	2879498-458	2879940-458
INDY RED	2881587-293	NA
	2-SEAT: TURBO S '18-21, XP TURBO '15-21, XP 1000 '14-23	
	4-SEAT: TURBO S 4 '19-21, XP 4 TURBO '16-21, XP 4 1000 '14-23	

EXTREME KICK-OUT ROCK SLIDERS

- Rugged steel protection and race-inspired styling
- Low-profile mounting location preserves ground clearance



2-SEAT

4.4 cm DIAMETER STEEL TUBE CONSTRUCTION



4-SEAT

COLOR	2-SEAT	4-SEAT
MATTE BLACK	2879456-458	2882079-458
INDY RED	2881586-293	NA
	2-SEAT: TURBO S '18-21, XP TURBO '15-21, XP 1000 '14-23	
	4-SEAT: TURBO S 4 '19-21, XP 4 TURBO '16-21, XP 4 1000 '14-23	



FULL COVERAGE FENDER FLARES

- Keep the mud, dirt and debris from launching off the tires and into your face
- Includes two, front only

» 2881985

TURBO S '18-21, TURBO S 4 '19-21, XP TURBO '15-21, XP 4 TURBO '16-21, XP 1000 '14-23, XP 4 1000 '14-23



MUD FLAPS

- Designed to specifically integrate into front fender flares
- Includes two, front only

» 2879938

TURBO S '18-21, TURBO S 4 '19-21, XP TURBO '15-21, XP 4 TURBO '16-21, XP 1000 '14-23, XP 4 1000 '14-23

> WINCHES



FEATURES	PRO PRO HEAVY DUTY SERIES	HD HEAVY DUTY SERIES	
RAPID ROPE RECOVERY	STANDARD	NOT AVAILABLE	
AUTO STOP TECHNOLOGY	STANDARD	OPTION	
WINCH LINE	SYNTHETIC ROPE	STEEL CABLE	
CONTROL	WIRELESS STANDARD, WIRED OPTION	WIRED STANDARD, WIRELESS OPTION	
MODEL	2,041 kg	1,588 kg	ADD REQUIRED CABLES
XP 4 1000 '14-23 XP 4 TURBO '16-21 XP 1000 '14-23 XP TURBO '15-21	TOP SELLER 2882240	TOP SELLER 2881671	XP 4 1000 / XP 1000 '19-23, XP 4 TURBO / XP TURBO '19-21 REQUIRE WINCH COVER KIT 2884118
TURBO S '18-21 TURBO S 4 '19-21	2883828		INCLUDED WITH WINCH

SYNTHETIC ROPE
2,041 kg SERIES
» 2879187

STEEL CABLE
1,588 kg SERIES
» 2878890

WIRED REMOTE CONTROL

- Must order remote handle and socket together

» **REMOTE HANDLE** 4013466
WORKS WITH 2882240, 2883828

» **SOCKET** 4014228
WORKS WITH 2882240, 2883828

WIRELESS REMOTE

- Up to 15 m range with LED indicator
- Direct plug & play operation

» 2879316

AUTO STOP UPGRADE

- Billet aluminum
- Replaces stock fairlead

» 2881693
SYNTHETIC ROPE REQUIRED

> STORAGE



LOCK & RIDE

45 L COOLER BOX

» 45.4 L 2881555

TURBO S '18-21, XP TURBO '15-21, TURBO S 4 '19-21, XP 4 TURBO '16-21, XP 4 1000 '14-23, XP 1000 '14-23



LOCK & RIDE

65 L CARGO BOX **TOP SELLER**

» 2881193

TURBO S '18-21, XP TURBO '15-21, TURBO S 4 '19-21, XP 4 TURBO '16-21, XP 4 1000 '14-23, XP 1000 '14-23



SPARE TIRE CARRIER

» 2883487
TURBO S '18-21, TURBO S 4 '19-21

» 2879464
XP TURBO '15-21, XP 4 TURBO '16-21, XP 1000 '14-23, XP 4 1000 '14-23



LOWER DOOR STORAGE BAG

» 2880613

TURBO S '18-21, XP TURBO '16-21, TURBO S 4 '19-21, XP 4 TURBO '16-21, XP 4 1000 '14-23, XP 1000 '14-23
REQUIRES LOWER DOOR INSERTS (2879509, 2879942)
ONLY COMPATIBLE WITH FRONT DOORS

LOCK & RIDE

D-RINGS

» 2881544

LOCK & RIDE

EXPANSION ANCHOR

» 2876420

BED D-RINGS

» 2877460

TURBO S '18-21, XP TURBO '15-21, TURBO S 4 '19-21, XP 4 TURBO '16-21, XP 4 1000 '14-23, XP 1000 '14-23

> AUDIO



BASE UNIT OR ADD SPEAKERS

AUDIO ROOF

- Use as an all-in-one solution or a base unit to build your system
- Four high-efficiency 16.5 cm coaxial speakers for unbeatable sound
- Built in push-button dash radio with Bluetooth and AUX
- Modular design for improved serviceability and access
- Not compatible with RIDE COMMAND

S4 AUDIO ROOF

» 2882064
XP TURBO '15-21, XP 1000 '14-23

S8 AUDIO ROOF

» 2882065
XP TURBO '15-21, XP 1000 '14-23

	MODEL: S4	S8
(4) 16.5 cm COAXIAL SPEAKERS	✗	✗
(4) 16.5 cm COMPONENT SPEAKERS, MIDS & TWEETERS		✗
4-CHANNEL, 2-OHM, 300W AMPLIFIER		✗
83.8 cm SINGLE-ROW PRO ARMOR LIGHT BAR		✗
DOME LIGHT		✗



Sound Bar 8



Sound Bar 4

SOUND BAR

- All-in-one solution for a quick and easy audio upgrade to your machine

SOUND BAR 8

- Six mid-range/mid-bass speakers and two dedicated tweeters
 - Fully waterproof with large, easy-to-use external controls
- » 2881465
XP TURBO '15-21, XP 1000 '14-23, XP 4 TURBO '16-21, XP 4 1000 '14-23
SPEAKER BAR HARNESS (2882167) REQUIRED

SOUND BAR 4

- Two mid-range/mid-bass speakers and two dedicated tweeters
- » 2881230
XP TURBO '15-21, XP 1000 '14-23, XP 4 TURBO '16-21, XP 4 1000 '14-23
SPEAKER BAR HARNESS (2882167) REQUIRED

NOT COMPATIBLE WITH ADDITIONAL/EXTERNAL SPEAKERS OR RIDE COMMAND



DOOR SPEAKERS **TOP SELLER**

- 16.5 cm component speakers with 1.9 cm titanium dome tweeters
- Works with Polaris Aluminum Door kits or Polaris Lower Door kits
- Harnessing included to connect to audio amplifier
- Use with RIDE COMMAND requires Audio Amplifier (2884064)

» **FRONT • 2881989** (Set of two)
TURBO S '18-21, XP TURBO '15-21, TURBO S 4 '19-21, XP 4 TURBO '16-21, XP 4 1000 '14-23, XP 1000 '14-23
NOT COMPATIBLE WITH DYNAMIX ACTIVE SUSPENSION MODELS

» **REAR • 2883116** (Set of two)
TURBO S 4 '19-21, XP 4 TURBO '16-21, XP 4 1000 '14-23
REQUIRES FRONT DOOR SPEAKERS (2881989). CONNECTS DIRECTLY TO AUDIO AMPLIFIER (2884064). NO ADDITIONAL AMPLIFIER NEEDED. NOT COMPATIBLE WITH AUDIO ROOFS.

» **AUDIO AMPLIFIER • 2884064**
TURBO S '18-21, XP TURBO '19-21, TURBO S 4 '20-21, XP 4 TURBO '19-21, XP 4 1000 '19-23, XP 1000 '19-23
REQUIRED WITH DOOR SPEAKERS (2881989, 2883116)

AUDIO Y-HARNESS

- Y-Harness splits the audio signal to allow for additional audio components to be added

» 2883269
TURBO S '18-21, XP TURBO '19-21, TURBO S 4 '20-21, XP 4 TURBO '19-21, XP 4 1000 '14-23, XP 1000 '14-23

LINE-OUT AUDIO HARNESS

- Designed to extend JST audio signal from rear of audio roof to the front of the vehicle

» 2881652
TURBO S '18-21, XP TURBO '19-21, TURBO S 4 '20-21, XP 4 TURBO '19-21, XP 4 1000 '14-23, XP 1000 '14-23

RIDE COMMAND AUDIO ADAPTER

- Required to hook up any audio RIDE COMMAND system
- Connect up to two speaker options and subwoofer

» 2883232
TURBO S '18-21, XP TURBO '19-21, TURBO S 4 '20-21, XP 4 TURBO '19-21, XP 4 1000 '14-23, XP 1000 '14-23
REQUIRED WHEN ADDING AUDIO TO 7" DISPLAY (2884072)

POLARIS
RZR TRAIL



TRAIL AGILITY.
ENDLESS COMFORT.



> **PERSONALIZED COMFORT**

All the essentials to customize your cab for comfortable riding in any element.

WINDSHIELDS P. 67
ROOFS P. 68
DOORS P. 68
HEATER KIT P. 72



> **PREMIUM TECHNOLOGY**

Take on the trails with unrivaled tech components, ranging from functional to fun.

ROCKFORD FOSGATE AUDIO P. 69
POLARIS PULSE P. 74
LIGHTING P. 74
RIDE COMMAND P. 82



PLUG & PLAY ELECTRICAL

EFFORTLESSLY ADD LIGHTS, AUDIO & WINCH



> **ULTIMATE DURABILITY**

Cover your bases with ease and protection, giving you confidence to stay riding longer.

PROTECTION P. 70
STORAGE P. 71
PRO ARMOR WHEELS & TIRES P. 84



> EXPLORER COLLECTION

Feel confident to take on the trails with all the essentials you need.

2889537	TIP OUT WINDSHIELD - HARD COAT POLY	P. 67
2884729	LOCK & RIDE POLY SPORT ROOF	P. 68
2884732-458	FRONT HIGH COVERAGE BUMPER	P. 70
2884734-458	REAR BUMPER EXTENSION ¹	P. 70

2883763	PREMIUM CONVEX REARVIEW MIRROR	P. 103
2884524	ADJUSTABLE FOLDING SIDE MIRRORS	P. 103
2884912	STAGE 1 PMX AUDIO KIT BY ROCKFORD FOSGATE ²	P. 69
2883945	REAR SPEAKER PODS BY ROCKFORD FOSGATE ²	P. 69

2415652	REAR SPEAKER POD AUDIO HARNESS	P. 69
2884871	ACCENT LIGHTS [*]	P. 80
2883123	RIGID SR-SERIES 10" COMBO LED LIGHT	P. 81
2884657	LIGHT BAR HARNESS	P. 81

2884762	SPARE TIRE CARRIER	P. 71
2883216	PRO ARMOR WHEEL & TIRE SET: 4301 BEADLOCK & DUAL THREAT, 26" ^{**}	P. 98
5416340	PRO ARMOR SPARE TIRE: DUAL THREAT, 26" ^{**}	P. 89
1523283	PRO ARMOR SPARE WHEEL: 4301 BEADLOCK, 14"	P. 97

Shown on Trail.
^{*}Accent lights come stock on Premium/Ultimate models (U.S. models).
^{**}May widen vehicle beyond 50".
¹U.S. models only.



TRAILBLAZER COLLECTION

Lead the charge with ultimate protection to enjoy the turns of the trails.

2884911	LOCK & RIDE FULL VENTED WINDSHIELD - HARD COAT POLY	P. 67	2883763	PREMIUM CONVEX REARVIEW MIRROR	P. 103
2884765	LOCK & RIDE POLY REAR PANEL*	P. 67	2884524	ADJUSTABLE FOLDING SIDE MIRRORS	P. 103
2884761-458	ALUMINUM ROOF	P. 68	2881193	LOCK & RIDE 65 L CARGO BOX	P. 71
2884868-458	FRONT WINCH BUMPER	P. 70	2885126	POLARIS PRO HD 4,500 LB WINCH WITH RAPID ROPE RECOVERY	P. 72
2884734-458	REAR BUMPER EXTENSION*	P. 70	2883157	PRO ARMOR WHEEL & TIRE SET: 5202 & ATTACK 2.0, 28"	P. 98
2879456-458	EXTREME KICK-OUT ROCK SLIDERS	P. 70	2879332	12MM x 1.5 SPLINED LUG NUTS WITH WRENCH ADAPTER	P. 96
2881985	FULL COVERAGE FENDER FLARES	P. 70			

Shown on Trail S.
*U.S. models only.



ADVENTURER COLLECTION

All-day riding made easy, with added comfort and maximum visibility.

2884756	FULL VENTED WINDSHIELD - GLASS	P. 67	2884648	RIGID SR-SERIES 81 CM COMBO LED LIGHT BAR	P. 74
2884755	WINDSHIELD WIPER - WASHER KIT	P. 67	2884650	81 CM LIGHT BAR MOUNT	P. 74
2884765*	LOCK & RIDE POLY REAR PANEL	P. 67	2884657	LIGHT BAR HARNESS	P. 74
2884729	LOCK & RIDE POLY SPORT ROOF	P. 68	2884183	POLARIS PULSE UNDERHOOD BUS BAR - 6 POSITION	P. 74
2884733	CANVAS UPPER DOORS, 60"	P. 68	2881556	LOCK & RIDE 48 L COOLER BOX*	P. 71
2884019-293	FRONT LOW PROFILE BUMPER	P. 70	2885126	POLARIS PRO HD 4,500 LB WINCH WITH RAPID ROPE RECOVERY	P. 72
2881587-293	LOW PROFILE ROCK SLIDERS	P. 70	2883182	PRO ARMOR WHEEL & TIRE SET: 5203 BEADLOCK & CRAWLER X6, 28"	P. 98
2883763	PREMIUM CONVEX REARVIEW MIRROR	P. 103	1522240	15" FORGED BEADLOCK RING	P. 96
2884735	HEATER KIT	P. 72	2879332	12MM x 1.5 SPLINED LUG NUTS WITH WRENCH ADAPTER	P. 96
2884917	FACTORY AUDIO STAGE 3 UPGRADE BY ROCKFORD FOSGATE	P. 69			

Shown on Trail S.
*U.S. models only.



> BUILD YOUR CAB

ADD COMFORT AND STYLE WITH END-TO-END PROTECTION

ADD A WINDSHIELD
Protect yourself and your passenger with optical clarity.

ADD A ROOF
Shield from harsh elements while adding style.

ADD A REAR PANEL
Maintain rear visibility while reducing rear air swirl.

ADD DOORS
Keep the cab free of debris and water.



LOCK & RIDE

REVOLUTIONARY INSTALLATION

Lock & Ride clamps make for easy on-off and eliminate the risk of cracking.



GASKETED SEAL

Keeps drafts and moisture out. Reduces ride chatter on full glass windshields.

POLARIS ENGINEERED ADVANTAGES

WINDSHIELDS GLASS



FULL VENTED WINDSHIELD - GLASS

- Double layer laminated, tempered glass windshield with steel powder-coated frame and center adjustable vent
- » 2884756
TRAIL S '21-23, TRAIL '21-23



WINDSHIELD WIPER - WASHER KIT

- Simple to control, featuring a multi-speed dash-mounted rocker switch
 - Includes a washer fluid reservoir
- » 2884755
TRAIL S '21-23, TRAIL '21-23
COMPATIBLE WITH GLASS WINDSHIELD ONLY

HARD COAT POLY



LOCK & RIDE

FULL VENTED WINDSHIELD - HARD COAT POLY

- Impact-resistant, long-lasting .64 cm durable hard coated polycarbonate
 - Full protection with airflow vents that quickly open for cockpit ventilation
- » 2884911
TRAIL S '21-23, TRAIL '21-23



LOCK & RIDE

FULL WINDSHIELD - HARD COAT POLY

- Impact-resistant, long-lasting .64 cm durable hard coated polycarbonate
 - No frame design offers maximum visibility
 - Integrates with all cab components
- » 2884757
TRAIL S '21-23, TRAIL '21-23



TIP OUT WINDSHIELD - HARD COAT POLY

- Hard coated polycarbonate panel windshield that offers three positions: closed, vented and full open
 - Single-handed latch with gas support struts
- » 2889537
TRAIL S '21-23, TRAIL '21-23



LOCK & RIDE

HALF WINDSHIELD - HARD COAT POLY

- Impact-resistant, long-lasting .64 cm durable hard coated polycarbonate
 - Provides protection and airflow into the cab
 - 17.8 cm tall
- » 2884768
TRAIL S '21-23, TRAIL '21-23

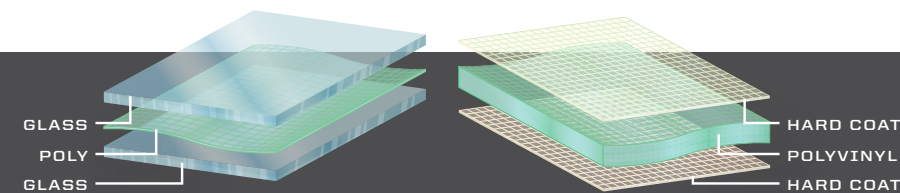

GLASS VS HARD COAT POLY

- Superior optical clarity (automotive level)
- Scratch-resistant
- Seals tight
- Cold weather/heavy duty
- Lightweight, flexible, easy to store/remove
- Impact-resistant
- 30x more scratch resistance than regular poly windshields

REAR PANEL



LOCK & RIDE

POLY REAR PANEL

- Maintains rear visibility and reduces rear air swirl from entering the cockpit
 - Fully compatible with all accessories
 - If installed, Rear Audio Pods should project backwards
- » 2884765
TRAIL S '21-23, TRAIL '21-23
U.S. MODELS ONLY

RECOMMENDED BUILD 1

- 2889537 TIP OUT WINDSHIELD - HARD COAT POLY
- 2884765 **LOCK & RIDE** POLY REAR PANEL**
- 2884761-458 ALUMINUM ROOF
- 2884733 CANVAS UPPER DOORS, 60" *

RECOMMENDED BUILD 2

- 2884756 FULL VENTED WINDSHIELD - GLASS
- 2884755 WINDSHIELD WIPER - WASHER KIT
- 2884765 **LOCK & RIDE** POLY REAR PANEL**
- 2884729 **LOCK & RIDE** POLY SPORT ROOF
- 2884733 CANVAS UPPER DOORS, 60" *

*Trail models should use Canvas Upper Doors, 50" (2884758)
**U.S. models only.



> ROOFS

ALUMINUM VS POLY

- High protection strength
- Lower profile
- Sleek style

- Water run-off channels
- Quick install
- Lightweight



ALUMINUM

ALUMINUM ROOF

- Seals to the roll cage for the best protection, while seamlessly integrating with other RZR accessories
- Strong and durable aluminum construction for long-lasting, reliable protection

COLOR	PART NUMBER
MATTE BLACK	2884761-458
INDY RED	2884761-293

TRAIL S '21-23, TRAIL '21-23

POLY

LOCK & RIDE POLY SPORT ROOF

- Rigid, injection-molded design to eliminate warping in high-heat conditions
- Integrated mounting locations for lighting
- Rugged, textured polyethylene construction for impact and abrasion resistance

COLOR	PART NUMBER
MATTE BLACK	2884729

TRAIL S '21-23, TRAIL '21-23
STANDARD ON ULTIMATE TRIM

> DOORS



CANVAS UPPER DOORS

- Pre-loaded tubular aluminum frame provides a tight seal along the roll cage
- Zip-down vinyl windows offer increased comfort in warmer conditions
- Zippered access ports for easy ingress and egress

- » 60" • 2884733
TRAIL S '21-23
- » 50" • 2884758 **NOT SHOWN**
TRAIL '21-23

ALUMINUM LOWER HALF DOORS

- Single-piece stamped aluminum maximizes quality, fit and finish
- Gasket design eliminates rattling and creates a firm seal

- » 2879510
TRAIL S '21-23



Rockford Fosgate partnered with Polaris to create the next evolution of factory-installed off road audio. Purpose built to stand up to any outdoor environment and designed to perform no matter the ride. Specifically tuned and rider-centric to create a class-leading audio experience that is second to none.

> AUDIO

BUILD YOUR SOUND
(CHOOSE THE PATH THAT MATCHES YOUR RZR)

NO FACTORY AUDIO

STEP 1

SELECT HEAD UNIT & ADD AUDIO

7" DISPLAY POWERED BY RIDE COMMAND*

2884072
TRAIL S '22-23

MOUNT KIT REQUIRED

2884731
TRAIL S '22-23

SEE P. 82 FOR FULL RIDE COMMAND DETAILS

OR

STAGE 1 PMX AUDIO KIT

2884912
TRAIL S '21-23, TRAIL '21-23

MOUNT KIT INCLUDED

+

STAGE 3 RIDE COMMAND AUDIO KIT

2884914
TRAIL S '22-23

STEP 2

UPGRADE AUDIO

REAR SPEAKER PODS

2883945
TRAIL S '21-23, TRAIL '21-23

REAR SPEAKER POD AUDIO HARNESS

2415652
TRAIL S '21-23, TRAIL '21-23

REQUIRED TO ADD PODS TO STAGE 1 OR STAGE 3



7" DISPLAY POWERED BY RIDE COMMAND*

» 2884072
TRAIL S '22-23
REQUIRES MOUNT KIT (2884731)
STANDARD ON ULTIMATE MODELS

SEE P. 82 FOR FULL RIDE COMMAND DETAILS



STAGE 1 PMX AUDIO KIT

- 6.86 cm full color display
- AM/FM/WB tuner w/ antenna**
- Bluetooth connectivity
- Includes mount kit
- Two front 16.5 cm coaxial speakers with enclosures

» 2884912
TRAIL S '21-23, TRAIL '21-23
NOT COMPATIBLE WITH ULTIMATE TRIM



STAGE 3 RIDE COMMAND AUDIO KIT FRONT SPEAKERS & SUBWOOFER

- 200 watt 25.4 cm subwoofer with enclosure
- 400 watt full range amplifier
- Two 50 watt 16.51 cm component speakers with enclosures

» 2884914
TRAIL S '21-23, TRAIL '21-23
NOT COMPATIBLE WITH ULTIMATE TRIM OR STAGE 1 PMX AUDIO KIT



REAR SPEAKER PODS USE WITH STAGE 1 OR STAGE 3

- 50 watt 16.51 cm coaxial speakers with can-enclosures, mounting hardware and grilles
- Audio Harness (2415652) required, sold separately

» 2883945
TRAIL S '21-23, TRAIL '21-23

* Due to ongoing supply chain issues, there may be delayed or limited availability of this product as an accessory add-on.
** The FM Frequency range is from 88 to 108 and only on the odds (i.e. 88.1, 88.3, etc.)

> VEHICLE PROTECTION

BUMPERS & FENDER FLARES



FRONT HIGH COVERAGE BUMPER

- Durable, powder-coated 4.45 cm tube steel with sleek profile for full coverage with headlight protection
- Does not cover Accent Lights

COLOR	PART NUMBER
■ MATTE BLACK	2884732-458
■ INDY RED	2884732-293

TRAIL S '21-23, TRAIL '21-23



FRONT LOW PROFILE BUMPER

- 4.45 cm powder-coated steel tubing provides impact protection and aggressive styling

COLOR	PART NUMBER
■ MATTE BLACK	2884019-458
■ INDY RED	2884019-293

TRAIL S '21-23, TRAIL '21-23



FRONT WINCH BUMPER

- Elevated mounting location on bumper for easy access to 2,041 kg winch
- Requires winch (2885127, 2885126), sold separately

COLOR	PART NUMBER
■ MATTE BLACK	2884868-458

TRAIL S '21-23, TRAIL '21-23



REAR BUMPER EXTENSION

- Bumper extension quickly attaches to rear ROPS to provide additional taillight protection

COLOR	PART NUMBER
■ MATTE BLACK	2884734-458

TRAIL S '21-23, TRAIL '21-23 (U.S. MODEL ONLY)



REAR DELUXE BUMPER

- Rear bumper extension expressly developed for EU-Models

COLOR	PART NUMBER
■ MATTE BLACK	2880164-458

TRAIL S '21-23 EU MODEL



152.4 CM STYLE FENDER FLARES

- Stock replacement for Trail S
- Includes four, front and rear

» 2879434

TRAIL S '21-23, TRAIL '21-23



FULL COVERAGE FENDER FLARES

- Keep the mud, dirt and debris from launching off the tires and into your face
- Includes two, front only

» 2881985

TRAIL S '21-23, TRAIL '21-23

ROCK SLIDERS



10-GAUGE STAMPED STEEL
NO LOSS IN GROUND CLEARANCE



4.5cm STEEL TUBE CONSTRUCTION
EXTENDS FROM MACHINE FOR MAX
PROTECTION THROUGH ROUGH TERRAIN

LOW PROFILE

COLOR	PART NUMBER
■ MATTE BLACK	2879498-458
■ INDY RED	2881587-293

TRAIL S '21-23, TRAIL '21-23

EXTREME KICK-OUT

COLOR	PART NUMBER
■ MATTE BLACK	2879456-458
■ INDY RED	2881586-293

TRAIL S '21-23, TRAIL '21-23

ANCHOR MOUNTS

Tougher than conventional nuts and bolts, Expansion Anchor Mounts are engineered into every RZR, allowing for a fast install.

BUMPER ANCHOR PACK

- Four anchors and two bumper end caps included

» 2205114



UNEXPANDED EXPANDED

> STORAGE



LOCK & RIDE

48 L COOLER BOX

- One-piece, rotomolded construction for extreme durability
- Lid locks securely in place with rubber latches to protect cargo
- Heavy-duty hinges and weatherproof seal block moisture and dust
- Keeps food and beverages cool for 48+ hours, depending on conditions
- UV-fade resistant
- Installs quickly and easily without tools
- Easy to carry with integrated grab handles

» 2881556

TRAIL S '21-23, TRAIL '21-23 (U.S. MODEL ONLY)



LOCK & RIDE

65 L CARGO BOX TOP SELLER

- Integrated rear cargo box, touting 65 L of storage
- Secure latching lid with taut rubber strap tie-downs
- Lightweight design integrates seamlessly into the rear cargo bed
- Includes all mounting hardware for complete installation

» 2881193

TRAIL S '21-23, TRAIL '21-23



SPARE TIRE CARRIER

- Mounts to rear ROPS to keep cargo bed free
- Compatible with Rear Bumper Extension (2884734-458)
- Quick installation

» 2884762

TRAIL S '21-23, TRAIL '21-23 (U.S. MODEL ONLY)

BED D-RINGS

» 2877460

TRAIL S '21-23, TRAIL '21-23

LOCK & RIDE

D-RINGS

» 2881544

TRAIL S '21-23, TRAIL '21-23



MIRRORS

SEE P. 103



> WINCHES

FEATURES	PRO PRO HEAVY DUTY SERIES	HD HEAVY DUTY SERIES	
RAPID ROPE RECOVERY	STANDARD	NOT AVAILABLE	
AUTO STOP TECHNOLOGY	STANDARD	OPTION	
WINCH LINE	SYNTHETIC ROPE	STEEL CABLE	
CONTROL	WIRELESS & WIRED STANDARD	WIRED STANDARD, WIRELESS OPTION	
MODEL	2,041 kg	1,588 kg	ADD REQUIRED CABLES
TRAIL S '21-23 TRAIL '21-23	2885126 	2885127 	WINCH COVER KIT REQUIRED 2884118 TRAIL S '21-23, TRAIL '21-23

REPLACEMENT PARTS

15 M SYNTHETIC ROPE
2,041 kg SERIES
» 2879187



15 M STEEL CABLE
1,588 kg SERIES
» 2878890



UPGRADE YOUR HD WINCH

WIRELESS REMOTE

- Up to 15 m range with LED indicator
- Direct plug & play operation

» 2879316



AUTO STOP UPGRADE

- Billet aluminum
- Replaces stock fairlead

» 2881693
SYNTHETIC ROPE REQUIRED



> PLOWS

GLACIER HD PLOW SYSTEM

MAKE QUICK WORK OF SMALLER JOBS

Move snow with the tough and capable Glacier HD plow system and discover why a major snowfall can be the highlight of your week. With a robust frame, beefy poly and steel blade options, dismantling and amazing value, Glacier HD is a great choice in the dead of winter.

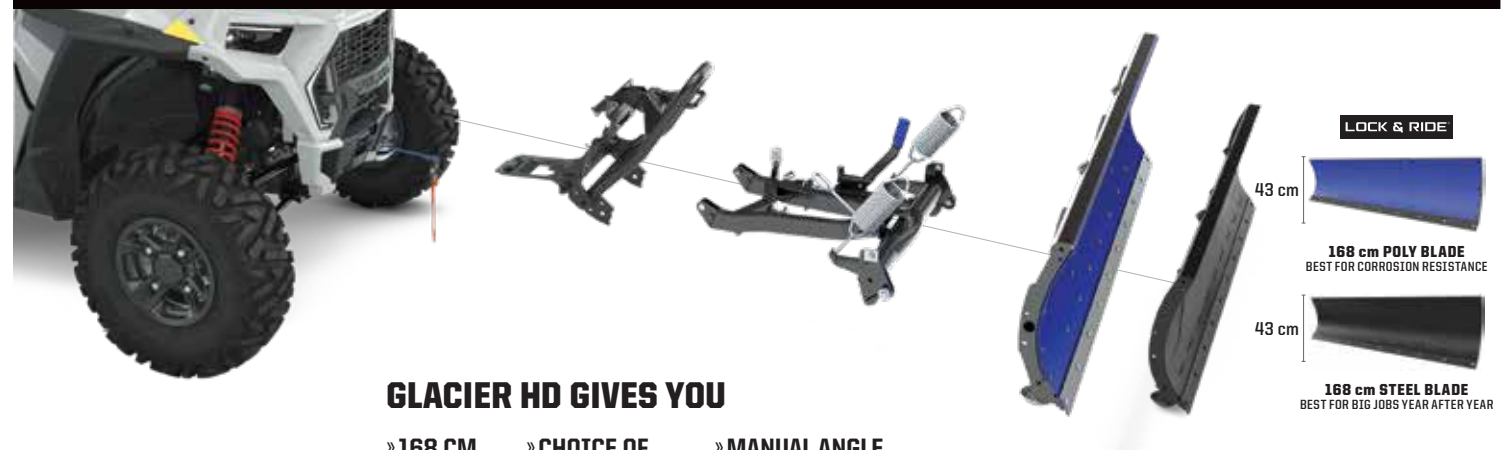

GLACIER HD GIVES YOU

- » 168 CM BLADES
- » CHOICE OF POLY OR STEEL
- » MANUAL ANGLE SYSTEM STANDARD

LOCK & RIDE
43 cm
168 cm POLY BLADE
BEST FOR CORROSION RESISTANCE
43 cm
168 cm STEEL BLADE
BEST FOR BIG JOBS YEAR AFTER YEAR

BUILD A PLOW SYSTEM

	STEP 1 SELECT A MOUNT	STEP 2 SELECT A FRAME	STEP 3 SELECT A LIFT METHOD	STEP 4 SELECT A BLADE	STEP 5 SELECT ACCESSORIES
MODELS	MOUNT	FRAME	WINCH	BLADES	ACCESSORIES
Trail S '21-23 Trail '21-23	Glacier Pro Plow Mount 2884764	Glacier Pro HD Push Frame 2880260	Polaris Pro HD 2,041 kg Winch with Rapid Rope Recovery See P. 72 for details Polaris HD 1,588 kg Winch See P. 72 for details	Glacier Pro Plow Blade 168 cm Poly 2880269 Glacier Pro Plow Blade 168 cm Steel 2880268	168 cm Snow Deflector 2879866 168 cm HD Wear Bar 2879868 168 cm Wear Bar 2879867 Plow Marker 2872726 Skid Shoe 2208864 Shear Pin 2205527 Plow Extension 2880267

BUY A PLOW SYSTEM

GLACIER HD PLOW SYSTEM

System includes:
• Mount (2884764)
• Frame (2880260)
• 168 cm Poly Plow (2880269)
• Plow Markers (2872726)
» 3880017
TRAIL S '21-23, TRAIL '21-23
REQUIRES WINCH

> HEATER



HEATER KIT

- Connects to Polaris PULSE Bus Bar to provide reliable, steady heat to your cab with fan speed and temperature control
- Selectable vent positions include driver/passenger, defrost or a combination of both
- Includes two defrost vents and two cabin vents
- Compatible with subwoofer upgrade

» 2884735
TRAIL S '21-23, TRAIL '21-23



> LIGHTING & ELECTRICAL

> TRACKS



RIGID SR-SERIES 81 CM COMBO LED LIGHT BAR

- » LIGHT BAR
2884648
TRAIL S '21-23, TRAIL '21-23
- » MOUNT (REQUIRED)
2884650
TRAIL S '21-23, TRAIL '21-23
- » HARNESS (REQUIRED)
2884657
TRAIL S '21-23, TRAIL '21-23



POLARIS PULSE UNDERHOOD BUS BAR - 6 POSITION

• If upgrading to have more than three accessories attaching to the underhood PULSE location, replace the 3 Position Bus Bar with the 6 Position Bus Bar

- » 2884183
TRAIL S '21-23, TRAIL '21-23

ADDITIONAL LIGHTING OPTIONS
SEE P. 80

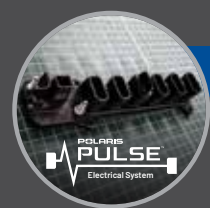

PLUG & PLAY ELECTRICAL

POLARIS PULSE IS A REVOLUTIONARY way to provide power to your vehicle, and makes adding electrical accessories a snap.



PROSPECTOR PRO 2.0 TRACK SYSTEM

TRACKS	MOUNTS	
» 2889487 TRAIL S '21-23, TRAIL '21-23 COMPATIBLE WITH PREMIUM/ULTIMATE ONLY	» 50" MODELS 2880648 TRAIL '21-23	» 60" MODELS 2880649 TRAIL S '21-23

PLOW EXTENSION (2880267) REQUIRED FOR USING A PLOW WITH TRACKS
ONLY COMPATIBLE WITH GLACIER PRO HD SYSTEM

1 INDUSTRY-FIRST FLEX-TRACK DESIGN

Front-mounted tracks with flexible sides and a slight inward curve allow for stable handling, a more comfortable ride and precise steering over long-distances or extended working hours.

2 HIGH-DENSITY TIRE WITH ADJUSTED SHAPE

With puncture-proof tires that reduce friction and wear, the Prospector Pro 2.0 Tracks deliver trouble-free performance.

Confidently take on bumps and obstacles with 8" high-density tracks.

3 LIGHTWEIGHT POWDER COAT STEEL FRAME

Proven geometry to improve durability and deliver capability in all conditions throughout the life of the tracks.

A lighter frame provides more flotation to stay on top of the snow and allows the tracks to easily shed the elements they encounter.

4 TANDEM STABILIZER

The bolt-on, tandem mid-roller wheel provides a smoother ride by absorbing shocks.

5 BEARING HOUSING

Outer seals and stainless steel sleeves allow stronger bearing durability and greater reliability.

6 WHEEL CAP & SEAL

A fitted wheel cap with bladder effect eliminates water absorption due to temperature variation. Ride in snow or mud without worrying about track maintenance.

FROM DUSK

Extend your ride time and be more visible to others with the brightest light bars in the industry.

RIGID LIGHT BARS P.80

A trusted name in the off road lighting industry, RIGID delivers unmatched technology and superior performance.

'TIL DAWN

PRO ARMOR LIGHT BARS P.81

Pro Armor gives you aggressive styling, rugged protection and lighting solutions for your riding needs.



BUILD YOUR VISION

OPTICS

ACCENT

USAGE

DIFFUSED COLORED LIGHT ADDED FOR STYLE & PERSONALIZATION

- Durable, dust and water resistant construction
- Ideal for showcasing your lifted vehicle or custom suspension



DRIVING

GREAT FOR ALL RIDING STYLES, TERRAINS OR WORK APPLICATIONS

- Beam: Extra-wide, moderate center intensity
- Recommended Mounting: All points



FLOOD

BEST FOR WIDE-OPEN TERRAINS OR WORK APPLICATIONS REQUIRING BROAD LIGHT

- Beam: Wide, shorter
- Recommended Mounting: Low & rear
- Ideal for medium speeds when peripheral vision is important



SPOT

BEST FOR TIGHT RIDING TERRAINS AND CONDITIONS REQUIRING LONG-DISTANCE VISIBILITY

- Beam: Concentrated long beam
- Recommended Mounting: High
- Ideal for high speeds so you can see and react to your environment



COMBO

ALL-AROUND VERSATILITY FOR ANY RIDING TERRAIN, CONDITION OR WORK APPLICATION

- Beam: Combination of flood and spot optics
- Recommended Mounting: All points
- Ideal for all-around distance visibility



DRIVING SPEED

ALL

SLOW TO MEDIUM

SLOW TO MEDIUM

HIGH

ALL

LIGHT ANGLE

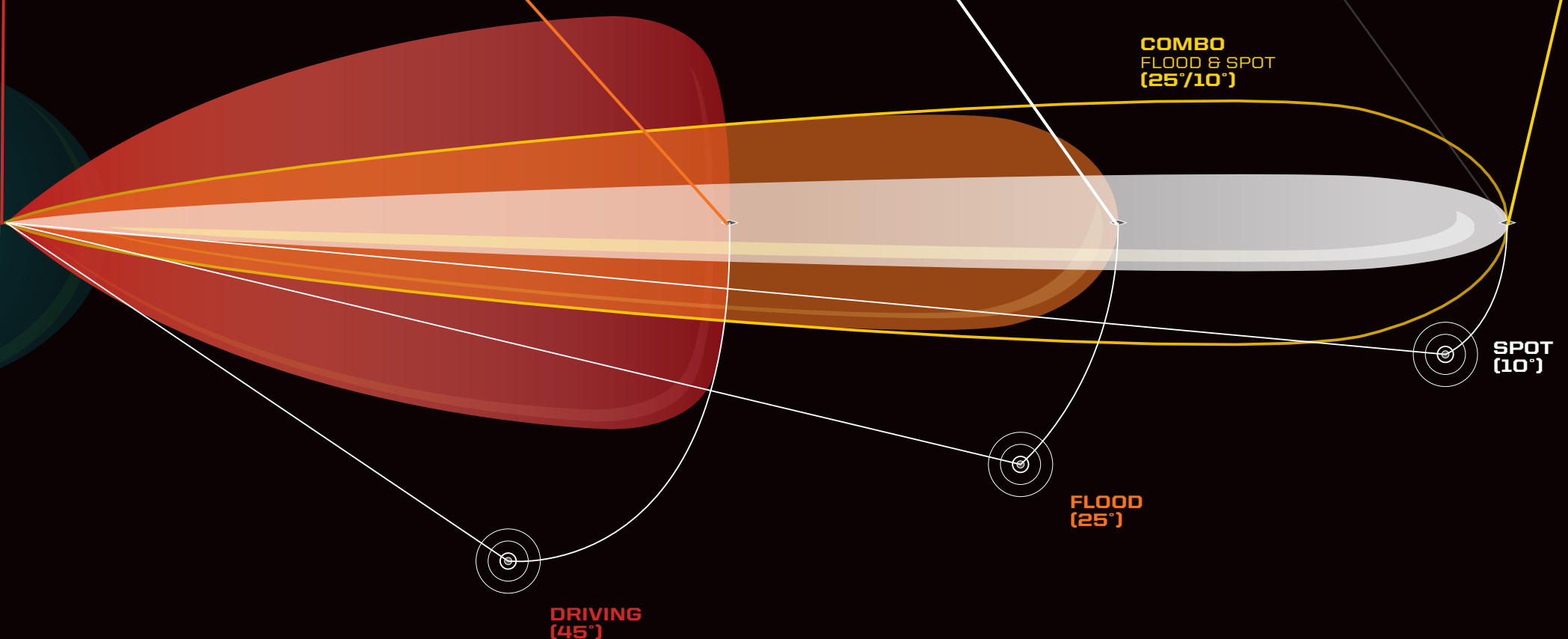

**CUSTOMIZE YOUR ILLUMINATION
MIX & MATCH LIGHTS**

COMMON

LIGHTING

CONNECTED TECHNOLOGY

WHEELS & TIRES

COOLERS

COCKPIT ACCESSORIES & MIRRORS

WINCHES

ADDITIONAL ACCESSORIES & YOUTH



POLARIS ENGINEERED ADVANTAGES

MOUNTS PERFECTLY
Designed for your Polaris Engineered bumper, roof or other mounting point

MAX PERFORMANCE
Validated to work as hard as your machine does

DOESN'T OVERTAX
Trust it to work when you need it to

PRO ARMOR



COMMON

LIGHTING

CONNECTED TECHNOLOGY

WHEELS & TIRES

COOLERS

COCKPIT ACCESSORIES & MIRRORS

WINCHES

ADDITIONAL ACCESSORIES & YOUTH

81

ADVANCED TECH

RIGID lights are driven by Aluminum PCB Smart Boards, 6063-T5 aircraft aluminum extruded housings and Tiger Drylac UV protection polyester powder-coating.

EXCLUSIVE OPTICS

RIGID invests heavily in optical science and has patented multiple optics and optics systems, maximizing light output and efficiency.

RUGGED CONSTRUCTION

Pro Armor lights are designed to be big and beefy with an aggressive style all their own, and housed in IP67 marine-grade rated UV polyester powder-coating.

MASSIVELY BRIGHT

Pro Armor builds bright lights designed for any riding experience. All that power is directed through heat dissipating aluminum for streamlined heat management.

LIGHT BAR TYPES



SR-SERIES PRO

Sleek, powerful, low-profile (under 5 cm tall). Lights extreme distances with low energy usage.
Available in 25.4 cm & 81.3 cm



D-SERIES PRO

Compact to fit almost anywhere with high output and low energy usage.
Available in Driving, Flood & Spot



DUAL-ROW LED

The most spread and farthest illumination downrange. Easy to mount.
Available in 27.9 cm & 78.7 cm



SINGLE-ROW LED

Powerful, compact, low-profile light bars with a sleek look.
Available in 27.9 cm, 50.8 cm & 83.8 cm



CUBE LED

Small size allows mounting in strategic locations for added lighting.
Available in Spot

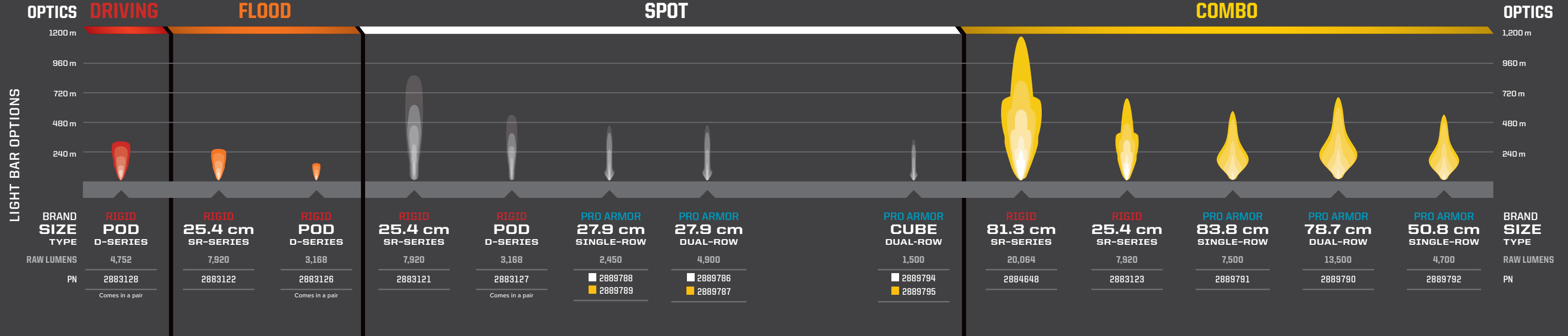

ACCENT LIGHTS

Includes a pair of front fascia accent lights and a rear, center taillight (rear light with kit only)

Durable dust and waterproof construction

FRONT/REAR KIT • 2884053

TURBO S '19-'21, XP TURBO '19-'21, TURBO S 4 '19-'21, XP 4 TURBO '19-'21, XP 4 1000 '19-'23, XP 1000 '19-'23 (U.S. MODELS ONLY)

FRONT • 2884871

TRAIL S '21-'23, TRAIL '21-'23, TURBO S '19-'21, XP TURBO '19-'21, TURBO S 4 '19-'21, XP 4 TURBO '19-'21, XP 4 1000 '19-'23, XP 1000 '19-'23 (U.S. MODELS ONLY)



ADD A HARNESS TO MOUNT YOUR LIGHTS

MODEL	LIGHT BAR SET-UPS	
	1 LIGHT IN 1 LOCATION ON 1 SWITCH	2 LIGHTS IN 2 LOCATIONS ON 1 SWITCH
TRAIL S '21-'23 TRAIL '21-'23	LIGHT BAR HARNESS 2884657	LIGHT BAR HARNESS 2884657 ADAPTER HARNESS 2412616 LED Y-HARNESS 2879860
PRO R 4 '22-'23 PRO R '22-'23 PRO XP 4 '20-'23 PRO XP '20-'23 TURBO R 4 '22-'23 TURBO R '22-'23	LIGHT BAR HARNESS 2883949 ADAPTER HARNESS 2412616	LIGHT BAR HARNESS 2883949 ADAPTER HARNESS 2412616 LED Y-HARNESS 2879860
XP 4 '24 XP '24	NEW LIGHT BAR HARNESS 2889291	NEW LIGHT BAR HARNESS 2889291 ADAPTER HARNESS 2412616 LED Y-HARNESS 2879860

NEW LIGHT BAR MOUNT

- Optional cast mount for added style
 - Compatible with all Pro Armor light bars
- » 2890053

ADDITIONAL LIGHT BAR OPTIONS

PRO R, TURBO R & PRO XP | SEE P. 30
XP | SEE P. 50

PULSED
Electrical System
All RIGID and Pro Armor lights are Polaris PULSE ready.

POLARIS RIDE COMMAND



ENHANCE YOUR RIDE WITH RIDE COMMAND

PLAN YOUR RIDE

Plan an epic ride with stops along the way, customize and adjust your path to maximize your route. You can even share your planned route with friends.

JOIN THE COMMUNITY

Discover new destinations and get inspired by checking out other rides in your area. You can even share your own rides for others to enjoy.

DISCOVER NEW TRAILS

With over 1,000,000 miles of trails available offline, you'll have the confidence to explore further, whether you have cellular coverage or not.

7" DISPLAY POWERED BY RIDE COMMAND*

- Bright, 7" touchscreen visible in all conditions
- **GPS Navigation & Pre-Loaded Maps**
Available offline on the in-dash display so you always know where you are.
- **Route Planning**
Add points of interest and waypoints to make the most of your off road adventure.
- **Camera Integration**
Navigate with full view of your surroundings. Use the integrated rear camera to see others behind you while riding.
- **Personalized Audio Experience**
Seamlessly pair your display via Bluetooth to wirelessly stream music and stay connected with call and text alerts.
- **Configurable Gauges**
Customize your ride experience with elevation, travel direction, fuel level and more to create relevant screens for you.

» 2884072

PRO R 4 '22-23, PRO R '22-23, XP 4 '24, XP '24, TURBO R 4 '22-23, TURBO R '22-23, PRO XP 4 '22-23, PRO XP '22-23, TRAIL S '22-23, TURBO S '19-21, XP TURBO '19-21, TURBO S 4 '19-21, XP 4 TURBO '19-21, XP 4 1000 '19-23, XP 1000 '19-23

XP 4 '24 & XP '24: OFF-ROAD USE ONLY ON TRACTOR AND ZUG VERSION

FRONT CAMERA KIT TOP SELLER

- Front camera upgrade for increased visibility and safety
- Increases driver awareness of obstacles and terrain for enhanced riding
- All wiring harnesses included on vehicle

» 2884432

PRO R 4 '22-23, PRO R '22-23, TURBO R 4 '22-23, TURBO R '22-23, PRO XP 4 '20-23, PRO XP '20-23, TRAIL S '22-23, TURBO S '19-21, XP TURBO '19-21, TURBO S 4 '19-21, XP 4 TURBO '19-21, XP 4 1000 '19-23, XP 1000 '19-23

» **NW** 2889169

XP 4 '24, XP '24

7" DISPLAY MOUNT KIT

- Replaces dash for seamless fit and finish
- Includes front and rear cameras with mounts
- Comes with wiring harnesses needed for RZR accessory components
- RIDE COMMAND Audio Adapter (2883232) required when adding audio to an XP

» 2884584

PRO R 4 '22-23, PRO R '22-23, TURBO R 4 '22-23, TURBO R '22-23, PRO XP 4 '20-23, PRO XP '20-23

» 2884731

TRAIL S '22-23

» **NW** 2889289

XP 4 '24, XP '24

» 2884021

TURBO S '19-21, XP TURBO '19-21, TURBO S 4 '19-21, XP 4 TURBO '19-21, XP 4 1000 '19-23, XP 1000 '19-23

*Due to ongoing supply chain issues, there may be delayed or limited availability of this product as an accessory add-on.



PRO ARMOR TIRES



TAKE ON ANY ENVIRONMENT FIND THE RIGHT PRO ARMOR TIRE FOR YOUR RZR

Developed and tested with Polaris engineers, ensuring the perfect fit and optimal performance mile after mile.



COMMON

LIGHTING

CONNECTED TECHNOLOGY

WHEELS & TIRES

COOLERS

COCKPIT ACCESSORIES & MIRRORS

WINCHES

ADDITIONAL ACCESSORIES & YOUTH

> WHEELS & TIRES

SUPERIOR PERFORMANCE & DURABILITY

LIFELONG PERFORMANCE

- Every tire is designed and constructed with longevity in mind
- 3,000+ mile rated (4,828 kilometers)

PREMIUM PROTECTION

- Pro Armor makes tires with extra protection exactly where it's needed most — the sidewall
- Triple-belted sidewalls keep your tires more resistant so you can keep going

TOUGH TIRES

- Higher ply ratings mean added protection
- Pro Armor builds 8 or 10-ply rated tires for higher puncture-resistance

KNOW YOUR TIRES

DIMENSIONS			USAGE	TREAD DEPTH	TIRE WEIGHT	PLY RATING	SIDEWALL BELTS	LOAD RATING
32" x 9" R15 Part Number			FRONT/REAR	30mm	18 kg	10	3	499 kg
TIRE HEIGHT	TIRE WIDTH	WHEEL DIAMETER	Where can you use the tire	Deeper treads have more grip in all conditions	A lighter tire makes for improved vehicle performance	Indicates tire puncture-resistance	Increase your resistance to sidewall punctures	How much weight can the tire handle

KNOW YOUR TERRAIN

- | | | | |
|---|--|---|---|
|  TRAIL | <ul style="list-style-type: none"> • Tread patterns optimized for extreme traction • Ideal for both hard pack & loose trail |  MUD | <ul style="list-style-type: none"> • Extra deep treads • Self-cleaning lugs |
|  DESERT | <ul style="list-style-type: none"> • Provides traction & durability • Performs in hard sand, jagged rocks or any extreme terrain |  SAND | <ul style="list-style-type: none"> • Paddles provide traction and durability in soft sand • Built to float on top of sand |
|  ROCK | <ul style="list-style-type: none"> • Flexible "grippy" tread • Aggressive side bite |  SNOW | <ul style="list-style-type: none"> • Handles extreme cold • Holds shape & provides traction |

KNOW YOUR WHEELS

STEP 1: SELECT YOUR SERIES

4 = 40-SERIES **5** = 50-SERIES **6** = 60-SERIES

STEP 2: CHOOSE YOUR LOAD RATING

1 = <362.9 KG **2** = 363 - 589.7 KG **3** = 590 - 726+ KG

STEP 3: PICK YOUR STYLE

OFFSET / BEADLOCK / COLOR

INCREASE OFFSET FROM STOCK = NARROWER STANCE
DECREASE OFFSET FROM STOCK = WIDER STANCE

WAYS TO SHOP >>>

TIRES BY SIZE

26"	27"	28"	29"	30"	32"	33"
ATTACK	MUD XC	ATTACK 2.0	DUAL-THREAT	ATTACK 2.0	ATTACK 2.0	CRAWLER XG
DUAL-THREAT	WHITEOUT	CRAWLER XG	HD-K	CRAWLER AT	DUAL-THREAT	CRAWLER XR
		CRAWLER XR	MUD XC	CRAWLER XG	CRAWLER AT	PRO RUNNER
				CRAWLER XR	CRAWLER XG	
				MUD XC	CRAWLER XR	
				PRO RUNNER	MUD XT	
				SAND 12XT	PRO RUNNER	
				SAND 16XT	SAND 16XT	
				WHITEOUT		

TIRES BY TERRAIN

TRAIL	ROCK	DESERT	MUD	SAND	SNOW
ATTACK	ATTACK 2.0	ATTACK	MUD XC	SAND 12XT	ATTACK
ATTACK 2.0	CRAWLER AT	ATTACK 2.0	MUD XT	SAND 16XT	ATTACK 2.0
CRAWLER AT	CRAWLER XG	CRAWLER AT			HD-K
CRAWLER XG	CRAWLER XR	CRAWLER XG			WHITEOUT
CRAWLER XR	DUAL-THREAT	CRAWLER XR			
DUAL-THREAT	PRO RUNNER	DUAL-THREAT			
HD-K		PRO RUNNER			
MUD XC					
PRO RUNNER					

WHEELS BY SIZE

14"	15"	16"
40-SERIES (16 TIRE OPTIONS)	50-SERIES (23 TIRE OPTIONS)	60-SERIES (1 TIRE OPTION)
4201	5101	6301 BEADLOCK
4202	5201	
4203 BEADLOCK	5202	
4204	5203 BEADLOCK	
4205	5204	
4206	5205	
4301 BEADLOCK	5206	
4302 BEADLOCK	5207	
4303	5208	
HD DUAL BEADLOCK	5301 BEADLOCK	
	5302 BEADLOCK	
	5303	
	5305 BEADLOCK	

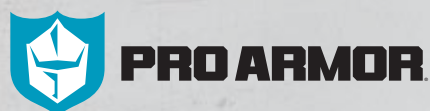



FRONT/REAR

PRO ARMOR ATTACK 2.0

- Engineered for excellent hard-pack performance
- Dual-compound technology and radial construction offer performance in all terrains
- Tight thread pattern for quieter ride

		TREAD DEPTH	TIRE WEIGHT	PLY RATING	SIDEWALL BELTS	LOAD RATING
15"	28" x 10" R15 5416344		15 kg			499 kg
15"	30" x 10" R15 5416345	FRONT/REAR 25mm	17 kg	10	3	560 kg
15"	32" x 10" R15 5418252		20 kg			630 kg



FRONT/REAR

PRO ARMOR DUAL-THREAT

- Dual-compound technology and radial construction offer performance in all terrains
- Softer durometer rubber on outer edge for overall superior grip and feel
- Harder durometer rubber in the middle for increased traction during acceleration and longer tread life

		TREAD DEPTH	TIRE WEIGHT	PLY RATING	SIDEWALL BELTS	LOAD RATING
14"	26" x 9" R14 5416340	FRONT	12 kg			413 kg
14"	26" x 11" R14 5416341	REAR	14 kg			504 kg
14"	29" x 9" R14 5416342	FRONT	16mm 14 kg	10	3	504 kg
14"	29" x 11" R14 5416343	REAR	16 kg			599 kg
15"	32" x 10" R15 5416753	FRONT/REAR	17 kg			902 kg



ATTACK 2.0

TIGHTER TREAD PATTERN =
Better traction in hard-pack

DUAL-DUROMETER LUG =
Increased grip & traction in rough terrain, smoother ride in all terrain

10-PLY RATED =
Increased durability

LARGER 28" & 30" SIZE OFFERING =
More ground clearance & trail traction

DUAL-COMPOUND =
MORE GRIP + LONGER LIFE

Firmer Durometer Rubber = Longer Life

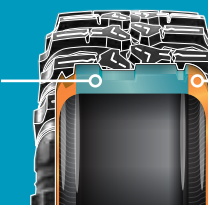

Softer Durometer Rubber = More Grip



FRONT/REAR

PRO ARMOR ATTACK

- The best all-purpose tire for all-season traction in any terrain
- Unique, full-face tread design
- Harder durometer lugs promote extended wear, increasing tire life
- Wider spaced lugs provide more grip in softer terrain

		TREAD DEPTH	TIRE WEIGHT	PLY RATING	SIDEWALL BELTS	LOAD RATING
14"	26" x 9" R14 5415613	FRONT	13 kg			413 kg
14"	26" x 11" R14 5415614	REAR	23mm 15 kg	8	3	599 kg



FRONT/REAR

PRO ARMOR PRO RUNNER

- Designed to be lightweight, high-performance and quicker in corners/flats
- Triple-belted sidewalls offer extra protection where it's needed the most
- Lug separation provides a great grip and an easy clean in mud and sand

		TREAD DEPTH	TIRE WEIGHT	PLY RATING	SIDEWALL BELTS	LOAD RATING
15"	30" x 9" R15 5417531		13 kg			531 kg
15"	32" x 9.5" R15 5417532	FRONT/REAR	14mm 16 kg	8	3	630 kg
15"	33" x 9.5" R15 5417533		17 kg			671 kg





FRONT/REAR

PRO ARMOR CRAWLER XR

- Premium grip for all terrains, from the trail to the rocks
- Square block profile for even surface contact
- A tougher durometer than the XG to take on the toughest a trail has to offer

		TREAD DEPTH	TIRE WEIGHT	PLY RATING	SIDEWALL BELTS	LOAD RATING
14"	28" x 10" R14 5415536	FRONT/ REAR 16mm	15 kg	8	3	517 kg
15"	30" x 10" R15 5418254		16.8 kg			581 kg
15"	32" x 10" R15 5416114		18 kg			630 kg
15"	33" x 10" R15 5417174		18 kg			630 kg



FRONT/REAR

PRO ARMOR CRAWLER XG

- Built to crawl over all obstacles, both large and small
- A soft, sticky compound makes this tire ideal for both rock crawling and desert running
- 8-ply, triple-belted ballistic sidewalls resist punctures

		TREAD DEPTH	TIRE WEIGHT	PLY RATING	SIDEWALL BELTS	LOAD RATING
14"	30" x 10" R14 5415616	FRONT/ REAR 20mm	17 kg	8	3	581 kg
14"	32" x 10" R14 5416113		19 kg			644 kg
15"	28" x 10" R15 5416346		15 kg			499 kg
15"	30" x 10" R15 5416397		18 kg			581 kg
15"	32" x 10" R15 5416699		19 kg			630 kg
15"	33" x 10" R15 5418255		20 kg			690 kg
16"	32" x 10.5" R16 5416401	20 kg	644 kg			



FRONT/REAR

PRO ARMOR CRAWLER AT

- Directional tread for optimal performance
- Greater lug separation for easy mud clean out
- 8-ply, triple-belted ballistic sidewalls resist punctures

		TREAD DEPTH	TIRE WEIGHT	PLY RATING	SIDEWALL BELTS	LOAD RATING
15"	30" x 10" R15 5417534	FRONT/ REAR 18mm	16 kg	8	3	580 kg
15"	32" x 10" R15 5417535		18 kg			630 kg



WHAT CRAWLER ARE YOU?



XR SINGLE DUROMETER

- Smaller lug height and single durometer gives this high-speed tire added rigidity and lateral stability when cornering
- Unique lug design excels in hard-pack, fast terrain



AT DIRECTIONAL LUG PATTERN

- The same taller lug height as Crawler XG, providing more grip and better traction
- Wider lug spacing for excellent mud clean-out



XG DUAL-DUROMETER

- Taller lug height and dual-durometer construction
- Perfect balance between high-speed performance, durability and flex in order to grip slick rock



WHAT PADDLE ARE YOU?



12 PADDLE

- 30" (Non-turbo RZR models)
- Fewer paddles for non-turbo/lower HP applications
- Perfect grip balance to maintain wheel speed



16 PADDLE

- 30" (Turbo RZR models)
- 32" (Turbo S and Velocity)
- Plenty of aggressive paddles for high HP vehicles
- Superior grip for wide-open sand riding



FRONT

REAR

PRO ARMOR SAND 12XT

- Unique 3-tier concave design on front tires
- Wider rear tires for more traction, plus better grip and flotation on the sand
- 12 paddles for optimized performance on non-turbo models
- 28mm paddle depth specifically designed for increased traction, while limiting sand throw

		TREAD DEPTH	TIRE WEIGHT	PLY RATING	SIDEWALL BELTS	LOAD RATING
14"	30" x 11" R14 5415251	FRONT 12.8mm	10 kg	8	2	388 kg
14"	30" x 13" R14 5416949	REAR 28mm	11 kg	4		476 kg



FRONT

REAR

PRO ARMOR SAND 16XT

- Unique 3-tier concave design on front tires
- Wider rear tires with additional paddles for more traction, better grip and flotation on the sand
- 16 paddles for optimized performance and traction on turbo models
- 28mm paddle depth specifically designed for increased traction, while limiting sand throw

		TREAD DEPTH	TIRE WEIGHT	PLY RATING	SIDEWALL BELTS	LOAD RATING
15"	30" x 11" R15 5416951	FRONT 13mm	10 kg	4	2	388 kg
15"	30" x 14" R15 5416953	REAR 28mm	15 kg			420 kg
15"	32" x 12" R15 5416952	FRONT 13mm	12 kg			463 kg
15"	32" x 15" R15 5416950	REAR 28mm	16 kg			581 kg





PRO ARMOR MUD XC

- Designed as the perfect mud-trail crossover for a smooth ride on the trail and aggressive traction in the mud
- Dual-compound technology with harder durometer lugs promote extended wear, increasing tire life
- 10-ply construction means added protection in the toughest terrain

		TREAD DEPTH	TIRE WEIGHT	PLY RATING	SIDEWALL BELTS	LOAD RATING
14"	27" x 9" R14 5416947	FRONT	14 kg	10	3	531 kg
14"	27" x 11" R14 5416948	REAR	14.5 kg			599 kg
14"	29" x 10" R14 5416946	FRONT/REAR	18 kg			41 kg
15"	30" x 10" R15 5418253	FRONT/REAR	18 kg			581 kg



PRO ARMOR HD-K

- Designed to provide a smooth ride and aggressive traction in all riding terrains
- Triple-belted sidewall provides extreme protection and extends the tire life
- Quad belt tread core offers superior protection and longer tread life

		TREAD DEPTH	TIRE WEIGHT	PLY RATING	SIDEWALL BELTS	LOAD RATING
14"	29" x 10" R14 5417507	FRONT/REAR	31.75mm	18 kg	10	3/1 Aramid 599 kg



PRO ARMOR MUD XT

- Aggressive traction in the mud
- Dual-compound technology with harder durometer lugs to promote extended wear and increase tire life
- 10-ply construction for added protection in the toughest terrain

		TREAD DEPTH	TIRE WEIGHT	PLY RATING	SIDEWALL BELTS	LOAD RATING
15"	32" x 9" R15 5417530	FRONT/REAR	30mm	18 kg	10	3 599 kg



PRO ARMOR WHITEOUT

- Extra wide tires for flotation in snow
- Cross-hatched tread pattern designed for superior snow traction with limited digging
- 2-ply sidewall designed to balloon for maximum use of its 15" wide contact patch
- Stud compatible

		TREAD DEPTH	TIRE WEIGHT	PLY RATING	SIDEWALL BELTS	LOAD RATING
14"	27" x 14" R14 5416032	FRONT	16mm	11 kg	8	2 424 kg
15"	30" x 15" R15 5416395	FRONT/REAR	17mm	21 kg	2	531 kg



MORE SURFACE AREA FOR BETTER FLOTATION ON SNOW

Snow-specific tire for trails and deep powder. Features an extra wide, bias-ply construction that can run at low pressures for maximum flexibility. High-flotation performance maintains critical vehicle ground clearance in the snow.

WHEELS



16"

60-SERIES

15"

50-SERIES

14"

40-SERIES

A 6301 BEADLOCK

WEIGHT: 6.1 kg LOAD RATING: 726 kg OFFSET: +38

ACCENT: FRONT/REAR 16" x 7" 1523286

MATTE BLACK: FRONT/REAR 16" x 7" 1523285

REPLACEMENT CAPS

POLARIS CAPS

HD	ALL 4-LUG WHEELS	5457498-458
-----------	------------------	-------------

PRO ARMOR CAPS

LUSTER	ALL 4-LUG WHEELS EXCEPT 5203 BEADLOCK, 5204, 5305 BEADLOCK	5453209-410
MATTE BLACK		5453209-458
LUSTER	5203 BEADLOCK	1523015-410
MATTE BLACK		1523015-458
MATTE BLACK	5204	1523063-458
MATTE BLACK	5206, 5207/5303 & 5302 BEADLOCK	5457756-458
MATTE BLACK	5305 BEADLOCK	1525502-458

LUG NUTS

LUG NUTS REQUIRED

12mm x 1.5 SPLINED LUG NUTS

16 LUG NUTS WITH WRENCH	XP 4 '24, XP '24, TRAIL 5 '21-23, TRAIL '21-23, TURBO S '18-21, XP TURBO '19-21, TURBO S 4 '20-21, XP 4 TURBO '19-21, XP 4 1000 '14-23, XP 1000 '14-23, S 900 '15-20, S 4 1000 '19-20, S 1000 '16-20, PRO XP '21-23, 900 '14-20	2879332
4 LUG NUTS WITHOUT WRENCH		2879331
SPLINED LUG WRENCH		2204966

B 5101

WEIGHT: 6.6 kg LOAD RATING: 363 kg OFFSET: -5

MATTE BLACK: FRONT/REAR 15" x 10" 1523149-458

C 5201

WEIGHT: 7.8 kg LOAD RATING: 590 kg OFFSET: +4

ACCENT: FRONT/REAR 15" x 7" 1523184-266

MATTE BLACK: FRONT/REAR 15" x 7" 1523184-458

D 5202

WEIGHT: 8.1 kg LOAD RATING: 590 kg OFFSET: +4

ACCENT: FRONT/REAR 15" x 7" 1523102-266

MATTE BLACK: FRONT/REAR 15" x 7" 1523102-458

E 5203 BEADLOCK

WEIGHT: 7.3 kg LOAD RATING: 590 kg OFFSET: +38

MATTE BLACK: FRONT/REAR 15" x 7" 1522435-458

F 5204

WEIGHT: 6.1 kg LOAD RATING: 590 kg OFFSET: +55

MATTE BLACK: FRONT/REAR 15" x 7" 1522550-458

G 5205

FRONT WEIGHT: 6.8 kg LOAD RATING: 408.2 kg OFFSET: -4
REAR WEIGHT: 9.1 kg LOAD RATING: 408.2 kg OFFSET: -38

MATTE BLACK: FRONT 15" x 8" 1523727-458
REAR 15" x 10" 1523728-458

H 5206

WEIGHT: 6.1 kg LOAD RATING: 590 kg OFFSET: +55

MATTE BLACK: FRONT/REAR 15" x 7" 1524041

ONLY COMPATIBLE WITH PRO R 4, PRO R, TURBO R 4 & TURBO R

I 5207/5303

FRONT WEIGHT: 6.1 kg LOAD RATING: 590 kg OFFSET: -4
REAR WEIGHT: 6.1 kg LOAD RATING: 590 kg OFFSET: -38

MATTE BLACK: FRONT 15" x 8" 1524043
REAR 15" x 10" 1524042

ONLY COMPATIBLE WITH PRO R 4, PRO R, TURBO R 4 & TURBO R

J 5208

WEIGHT: 5.8 kg LOAD RATING: 544 kg OFFSET: +55

MATTE BLACK: FRONT/REAR 15" x 7" 1525454

K 5301 BEADLOCK

WEIGHT: 7.7 kg LOAD RATING: 726 kg OFFSET: +38

ACCENT: FRONT/REAR 15" x 7" 1523282

MATTE BLACK: FRONT/REAR 15" x 7" 1523266

L 5302 BEADLOCK

WEIGHT: 6.1 kg LOAD RATING: 590 kg OFFSET: +55

MATTE BLACK: FRONT/REAR 15" x 7" 1524038

ONLY COMPATIBLE WITH PRO R 4, PRO R, TURBO R 4 & TURBO R

M 5305 BEADLOCK

WEIGHT: 8.4 kg LOAD RATING: 748 kg OFFSET: +38

MATTE BLACK: FRONT/REAR 15" x 7" 1525455

N 4201

FRONT WEIGHT: 5.9 kg LOAD RATING: 408.2 kg OFFSET: +9
REAR WEIGHT: 6.4 kg LOAD RATING: 590 kg OFFSET: +9

ACCENT: FRONT 14" x 7" 1522956-266
REAR 14" x 8" 1522957-266

MATTE BLACK: FRONT 14" x 7" 1522956-458
REAR 14" x 8" 1522957-458

NOT COMPATIBLE WITH XP 4 1000/1000 '18-23, XP 4 TURBO/TURBO '18-19

O 4202

FRONT WEIGHT: 5.8 kg LOAD RATING: 408.2 kg OFFSET: +4
REAR WEIGHT: 6.1 kg LOAD RATING: 590 kg OFFSET: -9

ACCENT: FRONT 14" x 7" 1522544-266
REAR 14" x 8" 1522545-266

MATTE BLACK: FRONT 14" x 7" 1522544-458
REAR 14" x 8" 1522545-458

NOT COMPATIBLE WITH XP 4 1000/1000 '18-23, XP 4 TURBO/TURBO '18-19

P 4203 BEADLOCK

FRONT WEIGHT: 5.9 kg LOAD RATING: 408.2 kg OFFSET: +4
REAR WEIGHT: 6.6 kg LOAD RATING: 590 kg OFFSET: -9

MATTE BLACK: FRONT 14" x 7" 1522238-458
REAR 14" x 8" 1522239-458

Q 4204

FRONT WEIGHT: 5.9 kg LOAD RATING: 408.2 kg OFFSET: +4
REAR WEIGHT: 6.4 kg LOAD RATING: 590 kg OFFSET: -9

ACCENT: FRONT 14" x 7" 1522546-266
REAR 14" x 8" 1522547-266

MATTE BLACK: FRONT 14" x 7" 1522546-458
REAR 14" x 8" 1522547-458

R 4205

FRONT WEIGHT: 4.8 kg LOAD RATING: 408.3 kg OFFSET: -9
REAR WEIGHT: 5.7 kg LOAD RATING: 590 kg OFFSET: -9

MATTE BLACK: FRONT 14" x 7" 1521507-521
REAR 14" x 8" 1521508-521

LUSTER: FRONT 14" x 7" 1521507-410
REAR 14" x 8" 1521508-410

S 4206

FRONT WEIGHT: 4.3 kg LOAD RATING: 408.2 kg OFFSET: +4
REAR WEIGHT: 4.9 kg LOAD RATING: 590 kg OFFSET: -9

MATTE BLACK: FRONT 14" x 6" 1522542-458
REAR 14" x 8" 1522543-458

T 4301 BEADLOCK

WEIGHT: 7.3 kg LOAD RATING: 726 kg OFFSET: +38

ACCENT: FRONT/REAR 14" x 7" 1523284

MATTE BLACK: FRONT/REAR 14" x 7" 1523283

NOT COMPATIBLE WITH XP 4 1000/1000 '18-23, XP 4 TURBO/TURBO '18-19

U 4302 BEADLOCK

WEIGHT: 18.1 kg LOAD RATING: 725.7 kg OFFSET: +58

MATTE BLACK: FRONT/REAR 14" x 7" 5418036

V 4303

WEIGHT: 18.1 kg LOAD RATING: 725.7 kg OFFSET: +58

MATTE BLACK: FRONT/REAR 14" x 7" 5418037

W HD DUAL BEADLOCK

WEIGHT: 18.1 kg LOAD RATING: 725.7 kg OFFSET: +28

MATTE BLACK: FRONT/REAR 14" x 7" 1524022-458

WHEELS WITH 5 LUG NUTS. ONLY COMPATIBLE WITH PRO R 4, PRO R, TURBO R 4 & TURBO R.

KNOW YOUR WHEELS

STEP 1: SELECT SERIES

- 4 = 40-SERIES
- 5 = 50-SERIES
- 6 = 60-SERIES

STEP 2: CHOOSE LOAD RATING

- 1 = <362.9 KG
- 2 = 363 - 589.7 KG
- 3 = 590 - 726+ KG

STEP 3: PICK STYLE

OFFSET / BEADLOCK / COLOR

INCREASE OFFSET FROM STOCK = NARROWER STANCE
DECREASE OFFSET FROM STOCK = WIDER STANCE



For off-road use only. Please check fitment with your dealer.

KNOW YOUR TERRAIN



- Tread patterns optimized for extreme traction
- Ideal for both hard-pack and loose trail



- Flexible "grippy" tread
- Aggressive side bite



- Provides traction and durability
- Built to perform in hard sand, jagged rocks or any other extreme terrain



- Extra deep treads
- Self-cleaning lugs



- Paddles provide traction and durability in soft sand
- Built to float on top of sand



- Triple-belted sidewalls to resist puncture
- Purpose-built, long lasting tread patterns



- Handles extreme cold
- Holds shape and provides traction

WHEEL & TIRE SETS

2 WAYS TO PURCHASE

INDIVIDUAL WHEELS & TIRES
- OR -
COMPLETE SETS AS LISTED

Exclusively at Polaris Authorized Dealers

14" 40-SERIES	BACKCOUNTRY/TRAIL			MUD		DESERT/ROCK			SAND	
	DUAL-THREAT 26"	DUAL-THREAT 29"	ATTACK 26"	MUD XC 27"	MUD XC 29"	CRAWLER XG 30"	CRAWLER XG 32"	CRAWLER XR 28"	SAND 12XT 30"	
4201 Accent	2883138	2883146	2882390	2884272	2884265	2882396	2882452	2882394		
4201 Matte Black	2883139	2883147	2882391	2884273	2884266	2882397	2882451	2882395		
4202 Accent	2883140	2883148	2881335	2884267	2884260	2881560	2882448	2881343		
4202 Matte Black	2883141	2883149	2881336	2884268	2884261	2881561	2882447	2881344		
4203 BEADLOCK Matte Black BEADLOCKS SOLD SEPARATELY			2881381				2881382	2881386		
4204 Accent	2883142	2883150	2881347	2884270	2884263	2881558	2882450	2881355		
4204 Matte Black	2883143	2883151	2881348	2884271	2884264	2881559	2882449	2881356	2884034	
4205 Luster			2881359				2881564	2881371		
4205 Matte Black	2883144	2883152	2881360	2884269	2884262	2881563	2882453	2881372		
4206 Matte Black	2883145	2883153	2881404							
4301 BEADLOCK Accent BEADLOCKS PRE-MOUNTED	2883217	2883219				2883211	2883215	2883213		
4301 BEADLOCK Matte Black BEADLOCKS PRE-MOUNTED	2883216	2883218				2883210	2883214	2883212		
4302 BEADLOCK Matte Black BEADLOCKS PRE-MOUNTED	2889550	2889551	2889549	2889552	2889553	2889555	2889556	2889554		
4303 Matte Black	2889542	2889543	2889541	2889544	2889545	2889547	2889548	2889546		

15" 50-SERIES	BACKCOUNTRY/TRAIL				MUD		DESERT/ROCK				SAND									
	DUAL-THREAT 32"	ATTACK 2.0 28"	ATTACK 2.0 30"	ATTACK 2.0 32"	MUD XC 30"	MUD XT 32"	PRO RUNNER 30"	PRO RUNNER 32"	PRO RUNNER 33"	CRAWLER XG 28"	CRAWLER XG 30"	CRAWLER XG 32"	CRAWLER XG 33"	CRAWLER XR 30"	CRAWLER XR 32"	CRAWLER XR 33"	CRAWLER AT 30"	CRAWLER AT 32"	15" SAND 16XT 30"	15" SAND 16XT 32"
5201 Accent	2883694	2883160	2883169	2890201	2890209				2883188	2883179	2889986	2890191	2890183	2883194	2884744	2889510	2889518	5205 Matte Black	2884035	2884036
5201 Matte Black	2883693	2883159	2883168	2890202	2890210				2883187	2883178	2889987	2890192	2890184	2883193	2884736	2889511	2889519	5207/5303 Matte Black		2885020
5202 Accent	2883696	2883158	2883167	2890203	2890211	2885052	2885024	2885031	2885038	2883186	2883177	2889988	2890193	2890185	2883192	2884737	2889512	2889520		
5202 Matte Black	2883695	2883157	2883166	2890204	2890212	2885053	2885025	2885032	2885039	2883185	2883176	2889989	2890194	2890186	2883191	2884738	2889513	2889521		
5203 BEADLOCK Matte Black BEADLOCKS SOLD SEPARATELY	2883699	2883154	2883163	2890205	2890213	2885056	2885028	2885035	2885042	2883182	2883173	2889992	2890195	2890187	2882444	2884741	2889516	2889524		
5204 Matte Black	2883700	2883155	2883164	2890206	2890214	2885058	2885030	2885037	2885044	2883183	2883174	2889993	2890196	2890188	2882445	2884743	2889517	2889525		
5206 Matte Black	2885015					2885019		2885017	2885018			2890026	2890199		2885016	2885014			5101 Matte Black	2883172
5208 Matte Black	2890181		2890179	2890180	2890182		2890176	2890177	2890178		2890166	2890167	2890168	2890171	2890172	2890173	2890174	2890175		
5301 BEADLOCK Accent BEADLOCKS PRE-MOUNTED	2883698	2883162	2883171	2890207	2890215	2885054	2885026	2885033	2885040	2883190	2883181	2889991	2890197	2890189	2883196	2884739	2889514	2889522		
5301 BEADLOCK Matte Black BEADLOCKS PRE-MOUNTED	2883697	2883161	2883170	2890208	2890216	2885055	2885027	2885034	2885041	2883189	2883180	2889990	2890198	2890190	2883195	2884740	2889515	2889523		
5302 BEADLOCK Matte Black	2885009					2885013		2885011	2885012			2890025	2890200		2885010	2885008				
5305 BEADLOCK Matte Black	2890164		2890162	2890163	2890165		2890159	2890160	2890161		2890149	2890150	2890151	2890154	2890155	2890156	2890157	2890158		

16" 60-SERIES	ROCK/RACE CRAWLER XG 32"
6301 BEADLOCK Accent BEADLOCKS PRE-MOUNTED	2883703
6301 BEADLOCK Matte Black BEADLOCKS PRE-MOUNTED	2883702

VALVES



COLBY SHORT ULTIMATE VALVE (2 PACK)

» 2883292



COLBY EMERGENCY VALVE (2 PACK)

» 2883293



ORDERABLE THROUGH LOCAL DEALER ONLY

COLBY COMBO VALVE KIT (16 PACK)

• Includes 8 ultimate and 8 emergency valves

» 2883294

⊗ LUG NUTS REQUIRED. SEE PREVIOUS PAGE FOR CAPS, BEADLOCK RINGS AND LUG NUTS.

⊕ WHEELS WITH 5 LUG NUTS. ONLY COMPATIBLE WITH PRO R 4, PRO R, TURBO R 4 & TURBO R.

COMMON

LIGHTING

CONNECTED TECHNOLOGY

WHEELS & TIRES

COOLERS

COCKPIT ACCESSORIES & MIRRORS

WINCHES

ADDITIONAL ACCESSORIES & YOUTH



KEEP IT
ICE COLD

GRIZZLY TESTED.
POLARIS APPROVED.



This cooler is IGBC-approved, meaning it withstands the power expended by a typical grizzly bear if it was trying to get inside.

Seriously, there are experts who know what a grizzly is capable of doing, and they certify our coolers can take it.



28, 57 & 99
LITER FEATURES



ComfortCarry Handles



TravelLock System



EasyOut Drain System



NoSlip Rubber Feet



PolarWall Insulation



IceLock Seal

POLARIS NORTHSTAR COOLERS CAN SURVIVE JUST ABOUT ANYTHING - FROM EXTREME HEAT TO A NASTY TUMBLE OFF A VEHICLE.



99 LITER

GRAPHITE • 2883426
DESERT • 2883392

ACCESSORIES

WIRE BASKET • 2883648
DIVIDER (1) • 2883468
WHEELS • 2883967

Divider:
1 way to
partition



57 LITER

GRAPHITE • 2883425
DESERT • 2881259

ACCESSORIES

WIRE BASKET • 2882185
DIVIDERS (2) • 2882184
SEAT CUSHION • 2882179
WHEELS • 2882180

Dividers:
2 ways to
partition



28 LITER

GRAPHITE • 2883424
DESERT • 2881315

ACCESSORIES

WIRE BASKET • 2882438
DIVIDER (1) • 2882186
SEAT CUSHION • 2882507

Divider:
1 way to
partition



14 LITER

GRAPHITE • 2883968



19 LITER
SOFT-SIDED COOLER

GRAPHITE • 2889285

ESSENTIAL ACCESSORIES SO YOUR COOLER WORKS AS HARD AS YOU DO



WIRE BASKET



DIVIDERS Doubles as cutting board



SEAT CUSHION



WHEELS



TUMBLER

591 mL • 2883393



BOTTLE OPENER

2882183



28 L COOLER BRACKET

2884070
TURBO R / 4 '22-23
PRO XP / 4 '20-23

2889200
PRO R / 4 '22-23
2884526
XP / 4 '24

> COCKPIT ACCESSORIES



HARNESSES

NOT AVAILABLE IN EUROPE



CLICK-6 HARNESS TOP SELLER

- Racing-quality, premium construction for increased security
- Six straps hold a driver securely in place in all riding conditions
- One-click, quick-release buckle releases straps, allowing easy egress
- Fully adjustable to fit riders of all sizes
- Easy to buckle and adjust, even while wearing helmet and gloves

DRIVER SIDE

» 2882244
TRAIL S '21-23, TRAIL '21-23,
TURBO S '18-21, XP TURBO '19-21,
TURBO S 4 '20-21, XP 4 TURBO '21,
XP 1000 '14-23, S 900 '15-20,
S 4 1000 '20, S 1000 '16-20, 900 '14-20

DOES NOT FIT 4-SEAT MODELS OR
HIGHLIFTER MODEL

» 2884075

PRO R '22-23, TURBO R '22-23,
PRO XP '20-23

» 2884077

PRO R 4 '22-23, TURBO R 4 '22-23,
PRO XP 4 '20-23

2-SEAT

» **NEW** 2890046
XP '24

PASSENGER SIDE

» 2882245
TRAIL S '21-23, TRAIL '21-23,
TURBO S '18-21, XP TURBO '19-21,
TURBO S 4 '20-21, XP 4 TURBO '21,
XP 1000 '14-23, S 900 '15-20,
S 4 1000 '20, S 1000 '16-20, 900 '14-20

DOES NOT FIT 4-SEAT MODELS OR
HIGHLIFTER MODEL

» 2884076

PRO R '22-23, TURBO R '22-23,
PRO XP '20-23

» 2884078

PRO R 4 '22-23, TURBO R 4 '22-23,
PRO XP 4 '20-23

4-SEAT FRONT

» **NEW** 2890048
XP 4 '24

REAR PASSENGER

» 2884079
PRO R 4 '22-23, TURBO R 4 '22-23,
PRO XP 4 '20-23

4-SEAT REAR

» **NEW** 2890049
XP 4 '24



RZR SUBZERO 4-PT HARNESS TOP SELLER

DRIVER SIDE

» 2882281
TRAIL S '21-23, TRAIL '21-23, TURBO S '18-21,
XP TURBO '15-21, XP 1000 '14-23, TURBO S 4 '19-21,
XP 4 TURBO '15-21, XP 4 1000 '14-23, S 900 '15-20,
S 4 1000 '19-20, S 1000 '16-20, 900 '14-20,
PRO XP 4 '20-23, PRO XP '20-23

PASSENGER SIDE

» 2882282
TRAIL S '21-23, TRAIL '21-23, TURBO S '18-21,
XP TURBO '15-21, XP 1000 '14-23, TURBO S 4
'19-21,
XP 4 TURBO '15-21, XP 4 1000 '14-23, S 900 '15-20,
S 4 1000 '19-20, S 1000 '16-20, 900 '14-20,
PRO XP 4 '20-23, PRO XP '20-23

2-SEAT

» **NEW** 2890047
XP '24

4-SEAT

» **NEW** FRONT • 2890050
XP 4 '24

» **NEW** REAR • 2890051
XP 4 '24

MIRRORS



ADJUSTABLE FOLDING SIDE MIRRORS

- Left and right mirrors included
- Installs in minutes and integrates into a designed mounting position
- Laminated safety glass for excellent scratch resistance

» 2884524

XP 4 '24, XP '24, TRAIL S '21-23, TRAIL '21-23, TURBO S '18-21, XP TURBO '19-21, XP 1000 '14-23, TURBO S 4
'20-21, XP 4 TURBO '19-21, XP 4 1000 '14-23, S 900 '15-20, S 4 1000 '19-20, S 1000 '16-20, 900 '14-20



PREMIUM CONVEX REARVIEW MIRROR TOP SELLER

- Installs in minutes and integrates into a designated mounting position
- Laminated safety glass for excellent scratch resistance

» 2883763

PRO R 4 '22-23, PRO R '22-23, XP 4 '24, XP '24, TURBO R 4 '22-23, TURBO R '22-23,
TRAIL S '21-23, TRAIL '21-23, PRO XP 4 '20-23, PRO XP '20-23



CONVEX DESIGN DELIVERS
WIDE REAR VIEW

REARVIEW MIRROR TOP SELLER

- Works with all roofs, soft tops and windshields

» 2877945

TURBO S '18-21, XP TURBO '15-21, XP 1000 '14-23,
TURBO S 4 '19-21, XP 4 TURBO '15-21, XP 4 1000 '14-23,
S 900 '15-20, S 4 1000 '19-20, S 1000 '16-20, 900 '14-20



SCRATCH-RESISTANT
GLASS MIRROR LENS

CONVEX REARVIEW MIRROR TOP SELLER

- Bolts into your choice of pre-designated mounting locations on the vehicle frame for easy install
- Convex design provides broad, expanded view of what's behind or alongside the vehicle

» 2881540

TURBO S '18-21, XP TURBO '15-21, XP 1000 '14-23,
TURBO S 4 '19-21, XP 4 TURBO '15-21, XP 4 1000 '14-23,
S 900 '15-20, S 4 1000 '19-20, S 1000 '16-20, 900 '14-20



QUICK GLANCE,
WIDE-ANGLE VIEWING FOR
MAXIMUM VISIBILITY

WIDE-ANGLE REARVIEW MIRROR

- Stamped steel frame and backing plate with large 6.4 cm x 35.6 cm convex mirror
- Up to 10° of range to adjust for rider height or view preference
- Easy over-structure installation with stamped steel mounts

» 2881199

TURBO S '18-21, XP TURBO '15-21, XP 1000 '14-23,
TURBO S 4 '19-21, XP 4 TURBO '15-21, XP 4 1000 '14-23,
S 900 '15-20, S 4 1000 '19-20, S 1000 '16-20, 900 '14-20

MISC

SEAT SLIDER

» 2879460

TURBO S '18-21, XP TURBO '15-21, XP 1000 '14-23,
TURBO S 4 '19-21, XP 4 TURBO '15-21, XP 4 1000 '14-23,
S 900 '15-20, S 4 1000 '19-20, S 1000 '16-20, 900 '14-20

SWITCH PANEL

- Adds five spaces for rocker switches without blocking storage

» 2881987

TURBO S '18-21, XP TURBO '15-21, XP 1000 '14-23,
TURBO S 4 '19-21, XP 4 TURBO '15-21, XP 4 1000 '14-23,
S 900 '15-20, S 4 1000 '19-20, S 1000 '16-20, 900 '14-20



> WINCHES

DEPENDABLE. TOUGH. BUILT FOR THE OFF ROAD.

A Polaris Engineered winch is designed to help you get the job done right, get you on your way faster and prepare you for the unexpected.

WHY POLARIS?

Polaris off road vehicles are engineered with designated mounting points and wiring for seamless install of Polaris Engineered winches.



TESTED **1,200+** PULLS AT MAX LOAD



BUILT TO WITHSTAND **-29° C** TEMPERATURES



OPERATES FULLY SUBMERGED



MILITARY TESTED & APPROVED

UPGRADE YOUR CONTROLS

WIRED REMOTE CONTROL

- » **WIRED REMOTE CONTROL**
2889562
WORKS WITH 2884835, 2884836
- » **REMOTE HANDLE**
4013466
WORKS WITH 2882240
SOCKET REQUIRED,
SOLD SEPARATELY
- » **SOCKET**
4014228
WORKS WITH 2882240
REMOTE HANDLE REQUIRED,
SOLD SEPARATELY

REPLACEMENT PARTS

- » **15 M STEEL CABLE**
1,588 kg SERIES
» 2878890
- » **15 M SYNTHETIC ROPE**
1,588 kg SERIES
» 2878888
- 2,041 kg SERIES
» 2879187

FEATURES & BENEFITS

ALL POLARIS ENGINEERED WINCHES COME WITH:

- ✓ INTEGRATED WIRING, MOUNT, PREASSEMBLED
- ✓ HOOK WITH STRAP
- ✓ CUT STEEL GEARS & SEALED DRIVETRAIN
- ✓ SEALED PERMANENT MAGNET MOTOR

	PRO PRO HEAVY DUTY SERIES	HD HEAVY DUTY SERIES
<p>Retrieve cable 5x as fast as standard mode on other Polaris winches. Get back to riding or complete your task quicker.</p> <ol style="list-style-type: none"> Set winch dial to N (Neutral) to manually pull the rope out and secure the hook to your anchor point. Set winch dial to L (Low) for maximum pulling power while winching your load. Set winch dial to H (High) for retrieving the rope 5x faster with Rapid Rope Recovery. 	✓	✓
<p>Auto Stop technology protects and extends the life of your winch by automatically stopping the winch at the end of pull to prevent over-spooling. While plowing, it prevents the plow frame from bending by stopping the winch once the plow has been lifted.</p>	✓	<p>NOT AVAILABLE</p> <p>ADD AUTO STOP UPGRADE 2881693 <small>SYNTHETIC ROPE REQUIRED</small></p>
<p>With its lightweight, yet extremely strong, design and superior flexibility, this 15 m long synthetic rope is easy to handle and can stand up to any tough job.</p>	✓	<p>ADD SYNTHETIC ROPE 2878888</p>
<p>This convenient remote operates your Polaris winch wirelessly from within 15 m of the vehicle. Operate your winch safely outside your vehicle while on the job site or trails.</p>	✓	<p>ADD WIRELESS REMOTE 2879316</p>

MODEL	2,721 kg	2,041 kg	2,041 kg	1,588 kg
PRO R 4 / PRO R '22-23 TURBO R 4 / TURBO R '22-23 <small>Includes both wired and wireless remote</small>	2884341	2884340		
XP 4 / XP '24 <small>Includes wireless remote. Wired remote sold separately</small>		NEW 2884836	NEW 2884835	
TRAIL S '21-23 TRAIL '21-23		2885126 <small>REQUIRES WINCH COVER KIT 2884118</small>		2885127 <small>REQUIRES WINCH COVER KIT 2884118</small>
PRO XP 4 / PRO XP '20-23 <small>Includes both wired and wireless remote</small>	2883759	2883758		

PRO PRO HEAVY DUTY SERIES TOP-OF-THE-LINE FEATURES BEST FOR PLOWING, HEAVY-DUTY OUTDOOR CHORES & TRAIL RIDING



HD HEAVY DUTY SERIES BUILT FOR THE OFF ROAD BEST FOR THE CASUAL OFF ROAD RIDER



PRO PRO HEAVY DUTY SERIES

HD HEAVY DUTY SERIES

COMMON

LIGHTING

CONNECTED TECHNOLOGY

WHEELS & TIRES

COOLERS

COCKPIT ACCESSORIES
MIRRORS

WINCHES

ADDITIONAL
ACCESSORIES & YOUTH

> ADDITIONAL ACCESSORIES

> YOUTH 200 EFI

RIDE & REPAIR ESSENTIALS KIT

» 2881207

PRO R 4 '22-23, PRO R '22-23, XP 4 '24, XP '24, TURBO R 4 '22-23, TURBO R '22-23, PRO XP 4 '20-23, PRO XP '20-23, TRAIL S '21-23, TRAIL '21-23, TURBO S '18-21, XP TURBO '15-21, XP 1000 '14-23, TURBO S 4 '19-21, XP 4 TURBO '15-21, XP 4 1000 '14-23, S 900 '15-20, S 4 1000 '19-20, S 1000 '16-20, 900 '14-20



LOCK & RIDE

RZR WHIP FLAG & POLE

» FLAG & POLE • 2881468

» MOUNT • 2877502

PRO R 4 '22-23, PRO R '22-23, XP 4 '24, XP '24, TURBO R 4 '22-23, TURBO R '22-23, PRO XP 4 '20-23, PRO XP '20-23, TRAIL S '21-23, TRAIL '21-23, TURBO S '18-21, XP TURBO '15-21, XP 1000 '14-23, TURBO S 4 '19-21, XP 4 TURBO '15-21, XP 4 1000 '14-23, S 900 '15-20, S 4 1000 '19-20, S 1000 '16-20, 900 '14-20



PREMIUM FILTER KIT TOP SELLER

- Polaris Ultraweb high performance air filter
- Provides superior engine protection with 99.99% efficiency
- Superior dust-holding capacity
- Lower restriction offers better performance for high horsepower, torque and acceleration

» 2882233

S 900 '15-20, S 4 1000 '19-20, S 1000 '16-20, 900 '14-20

» 2882234

XP 4 '24, XP '24, TURBO S '18-21, XP TURBO '19-21, TURBO S 4 '20-21, XP 4 TURBO '19-21, XP 4 1000 '14-23, XP 1000 '14-23, PRO XP '21-23

FIRE EXTINGUISHER MOUNT

» 2881200

PRO R 4 '22-23, PRO R '22-23, XP 4 '24, XP '24, TURBO R 4 '22-23, TURBO R '22-23, PRO XP 4 '20-23, PRO XP '20-23, TRAIL S '21-23, TRAIL '21-23, TURBO S '18-21, XP TURBO '15-21, XP 1000 '14-23, TURBO S 4 '19-21, XP 4 TURBO '15-21, XP 4 1000 '14-23, S 900 '15-20, S 4 1000 '19-20, S 1000 '16-20, 900 '14-20



LOCK & RIDE

FULL WINDSHIELD

- Made of durable polycarbonate to protect the cab from debris, dust, rain and wind
- Lock & Ride offers easy, toolless installation
- Integrates with the roof to prevent rain from entering the cab

» 2884570

200 EFI '22-23



LOCK & RIDE

HALF WINDSHIELD

- Made of durable polycarbonate to protect the cab from debris, dust, rain and wind
- Lock & Ride offers easy, toolless installation
- Fully seals at the base for lower protection from the elements, while the open top-half enables airflow

» 2884571

200 EFI '22-23



POLY REAR PANEL

- Made of durable .25" polycarbonate, which offers rider protection and visibility
- Installs quickly and easily with P-clamps
- Features scratch-resistant hard coating for enhanced durability

» 2889777

200 EFI '22-23

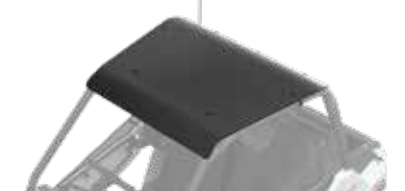

POLY ROOF

- Durable HDPE material provides protection from the weather
- 4-bolt installation
- Integrates with full windshield to provide complete cab coverage

» 2889739

200 EFI '22-23



BUMPERS

- Made of durable steel to provide great protection
- Chassis integrated mounting
- Front bumper offers integrated tow hook

» FRONT • 2884577

200 EFI '22-23

» REAR • 2885144

200 EFI '22-23



ROCK SLIDERS

- Add durable protection from rocks, stumps or other debris with steel rock sliders
- Chassis integrated mounting for easy install
- Comes with two steel rock sliders

» 2885146

200 EFI '22-23



REAR STORAGE BAG

- 3 L storage capacity
- Mounts to rear ROPS with a Velcro wrap
- Made to withstand the elements and wear with durable ballistic nylon construction

» 2885145

200 EFI '22-23



PRO ARMOR YOUTH COMBAT WHEEL

- Designed specifically for youth vehicles
- Increased strength and lightweight performance helps overcome obstacles on the trail
- Not compatible with stock lug nuts; Requires metric lug nuts (2877384, 2877385), sold separately

» FRONT • 12" x 7" • 1525222

200 EFI '22-23

» REAR • 12" x 7" • 1525421

200 EFI '22-23



NEW

PRO ARMOR YOUTH SAND 8XT TIRE

- 8 paddles for optimized performance
- Wider rear tires for better traction, grip and flotation on the sand

» FRONT • 24" x 8" R12 • 5418458

» REAR • 24" x 10" R12 • 5418459

200 EFI '22-23

	TREAD DEPTH	TIRE WEIGHT	PLY RATING	SIDEWALL BELTS	LOAD RATING
FRONT	8mm	7.5 kgs	4	2	206 kgs
REAR	16mm	8.2 kgs	4	2	256 kgs



PRO ARMOR YOUTH CRAWLER TIRE

- 25" design provides additional ground clearance
- Improved performance in all types of applications, from rock crawling to desert running
- Double-belted sidewall for additional puncture-resistance

» FRONT/REAR • 25" x 9.5" R12 • 5417953

200 EFI '22-23

	TREAD DEPTH	TIRE WEIGHT	PLY RATING	SIDEWALL BELTS	LOAD RATING
	13mm	10.5 kgs	6	2	437 kgs



NEW

PRO ARMOR WHEEL & TIRE SET: COMBAT & YOUTH SAND 8XT

- Not compatible with stock lug nuts; Requires metric lug nuts (2877384, 2877385), sold separately

» FOUR WHEELS & TIRES • 2890260

200 EFI '22-23



PRO ARMOR WHEEL & TIRE SET: COMBAT & YOUTH CRAWLER

- Not compatible with stock lug nuts; Requires metric lug nuts (2877384, 2877385), sold separately

» FOUR WHEELS & TIRES • 2889869

200 EFI '22-23

COMMON

LIGHTING

CONNECTED TECHNOLOGY

WHEELS & TIRES

COOLERS

COCKPIT ACCESSORIES & MIRRORS

WINCHES

ADDITIONAL ACCESSORIES & YOUTH

FOR THE LIFE OF YOUR RIDE

PARTS THAT PUSH THE LIMITS WITHOUT SACRIFICING STRENGTH AND DURABILITY.

We build our products so anyone with the right tools can maintain their vehicle.

POLARIS

ENGINEERED PARTS & LUBRICANTS

PARTS & GARAGE

MAINTENANCE

OIL & LUBRICANTS

MAINTENANCE FLUIDS

HO PARTS

SERVICE PARTS

CLEANERS & TRAILERING

MAINTENANCE TIP

BREAK-IN PERIOD

The break-in period for your new RZR is the first 25 hours of operation, 1 month, or the time it takes to use the first two tanks of fuel (whichever comes first). No single action on your part is as important as a proper break-in period. Careful treatment of a new engine will result in more efficient performance and longer life for the engine.

AIR FILTER

A clogged air filter can restrict air flow to the engine leading to reduced engine performance, engine life or catastrophic failure.

BRAKE PADS

Maintaining and/or replacing brakes are critical to the safety and functionality of a vehicle. Brake pads should be checked for wear and oil or grease (petroleum products) contamination and brake discs should be checked for cracks, excessive corrosion or warping.

HALF SHAFT

Check for tears and punctures in the boot, which can lead to CV joint wear that can contribute to axle failure.



DRIVE BELT

Polaris Engineered belts deliver unmatched performance for your off road vehicle. Developed and tested on all our engines for all environments and conditions. Check your belt for delamination, hour glassing and glazing.

BREAK-IN PERIOD

- Use lower gear (if available) while varying speeds and avoid wide open throttle for 8-16 km
- If no low gear is available, vary at moderate speeds while avoiding wide open throttle for 80 km

OUR INVESTMENT

- 64,000+ km of field testing
- Thousands of dyno hours
- 18+ months of development (13,000+ design hours) per belt
- 1,500+ vehicle validation hours
- Collaboration with powertrain and clutch engineers

YOUR ADVANTAGE

- No clutch recalibration
- Less wear and tear due to heat
- Ensure maximum vehicle performance
- More time riding, less time wrenching
- Produced in collaboration with powertrain and clutch engineers to ensure a perfect fit, maximum performance and ultimate durability

OIL FILTER

Change oil filters with every oil change to provide the best engine protection and keep the engine operating at peak performance.

BATTERY

To ensure a battery maintains its level of charge when unused for extended periods of time or during freezing weather, the battery should be connected to a suitable battery charger. Be sure to check for corrosion from the terminals to the ends of the cables.

FOLLOW RECOMMENDED SERVICE INTERVALS IN THE OWNER'S MANUAL

EXAMPLE MAINTENANCE SCHEDULE*

BREAK-IN MAINTENANCE

ENGINE OIL & OIL FILTER
CHANGE

GENERAL LUBRICATION
ALL FITTINGS, PIVOTS, CABLES, ETC.

AIR FILTER
INSPECT
REPLACE AS NEEDED

6 MONTHS

AIR FILTER
INSPECT
REPLACE AS NEEDED

GENERAL LUBRICATION
ALL FITTINGS, PIVOTS, CABLES, ETC.

DRIVE BELT
INSPECT & ADJUST
REPLACE AS NEEDED

12 MONTHS

ENGINE OIL & OIL FILTER
CHANGE

DRIVE BELT
INSPECT & CLEAN
REPLACE AS NEEDED

TRANSMISSION FLUID
CHANGE

AIR FILTER
INSPECT
REPLACE AS NEEDED

18 MONTHS

BATTERY
TEST & CLEAN
REPLACE AS NEEDED

DRIVE BELT
INSPECT & CLEAN
REPLACE AS NEEDED

TIRES
INSPECT CONDITION
& PRESSURE

AIR FILTER
INSPECT
REPLACE AS NEEDED

24 MONTHS

ENGINE OIL & OIL FILTER
CHANGE

BRAKE PADS & FLUID
REPLACE BRAKE FLUID

SPARK PLUGS
INSPECT
REPLACE AS NEEDED

AIR FILTER
INSPECT
REPLACE AS NEEDED

30 MONTHS

BATTERY
TEST & CLEAN
REPLACE AS NEEDED

SHOCK ABSORBERS
REPLACE OIL & SEALS

DRIVE BELT
INSPECT & CLEAN
REPLACE AS NEEDED

GENERAL LUBRICATION
ALL FITTINGS, PIVOTS, CABLES, ETC.

AIR FILTER
INSPECT
REPLACE AS NEEDED

36 MONTHS

ENGINE OIL & OIL FILTER
CHANGE

AIR FILTER
INSPECT
REPLACE AS NEEDED

TRANSMISSION & GEARCASES
REPLACE FLUIDS

TO FIND THE SPECIFIC MAINTENANCE SCHEDULE FOR YOUR VEHICLE, CHECK YOUR OWNERS MANUAL.

*This is a sample maintenance schedule and is not intended for use in your specific vehicle. Please reference and use your owners manual to ensure proper maintenance and vehicle care.

OIL

PS-4 FORMULATIONS BEST PROTECTION, BEST PERFORMANCE

Our new PS-4 5W-50 formulation and PS-4 Extreme Synthetic 0W-50 have been designed to provide the best fluid technologies for long lasting wear protection. These formulations include a new Polaris exclusive additive system to keep the engine cleaner from deposit build-up to maximize power and powersports-grade synthetic base stocks that provide the ultimate in engine protection.

PS-4 5W-50 FULL-SYNTHETIC OIL

Optimal for ambient operating temperatures of -40° C to 38° C

» 1L 502484 » 4L 502485 » 25L 502486 » 60L 502487 » 200L 502488

PS-4 0W-50 EXTREME FULL-SYNTHETIC OIL

Optimal for ambient operating temperatures of -43° C to 54° C

» 1L 503220 » 4L 503221 » 25L 503233 » 60L 503236 » 200L 503235

OIL CHANGE KITS

These convenient kits include everything needed including filter and oil volume per vehicle

PART NUMBER	VEHICLE FITMENT
502541	SINGLE 570, TWIN 600, TWIN 700, TWIN 800
502543	RANGER/RZR 900/1000
502542	SPORTSMAN 550/850/1000

ENGINE WEAR TEST LOWER NUMBER = LESS WEAR OF CRITICAL ENGINE PARTS LESS WEAR MEANS LONGER ENGINE LIFE

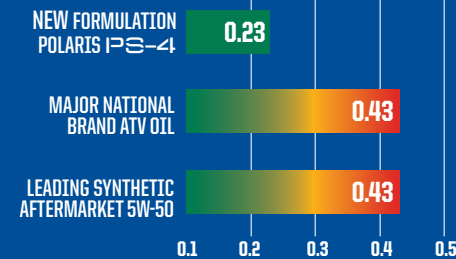

ASTM D4172. In 3rd party against 11 competitive products Polaris had 40% or better wear protection compared to all of the test products.

THE BEST PROTECTION

- At least 40% improved wear protection compared to previous Polaris PS-4 formulation and all aftermarket oils tested

Best engine protection against wear for the longest engine life.

DEPOSIT TEST LOWER DEPOSITS = MAXIMUM POWER

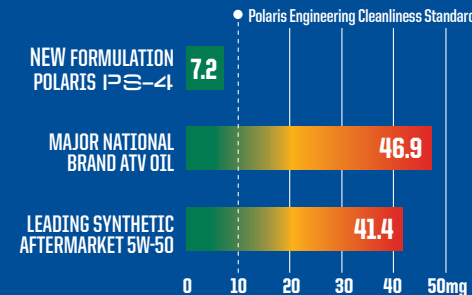

ASTM D6335. In 3rd party against 9 competitive products Polaris PS-4 had less than half the deposits compared to the next closest product. No other tested products met Polaris Engineering standards for deposit cleanliness.

MAXIMUM PERFORMANCE

- New improved PS-4 formulation provides 33% less deposits than previous PS-4 formula

- At least 50% less deposits than all aftermarket oils tested

The cleanest engine for maximum power and performance!

POLARIS EXTREME SYNTHETICS

Our new PS-4 Extreme Synthetic 0W-50 formulation applies only to the **absolute highest performance** products we sell, for ultimate protection and performance in the most extreme conditions.

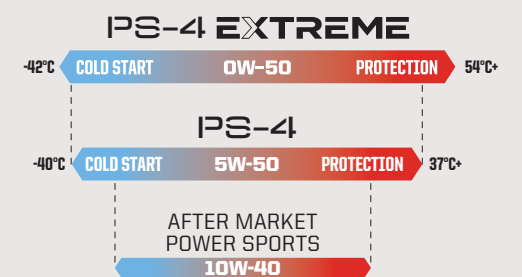

- Our best extreme high temp formulation, excellent for severe high temperatures and for racing, even at temps over 54°C.

- Provides easier starting and cold temperature protection, even to extreme cold temps of below -42°C.

- Latest in premium synthetic PAO and Ester base stocks along with careful balance of moly and ZDDP additives for ultimate long lasting wear protection.

- Polaris exclusive clean engine additive system reduces deposits and carbon build-up for peak performance and power.



POLARIS INVESTS IN EACH OIL AT AND ABOVE THESE LEVELS

12+ DEDICATED
TEAM MEMBERS

FOCUSED ON
POLARIS OIL

18+
MONTHS

DEVELOPMENT
& TESTING

76,000+
HOURS

DYNO
TESTING

3.5 MILLION+
KILOMETERS

FIELD
TESTING

MAINTENANCE FLUIDS



ENGINE OIL

Maximum protection for your 4-cycle engine.

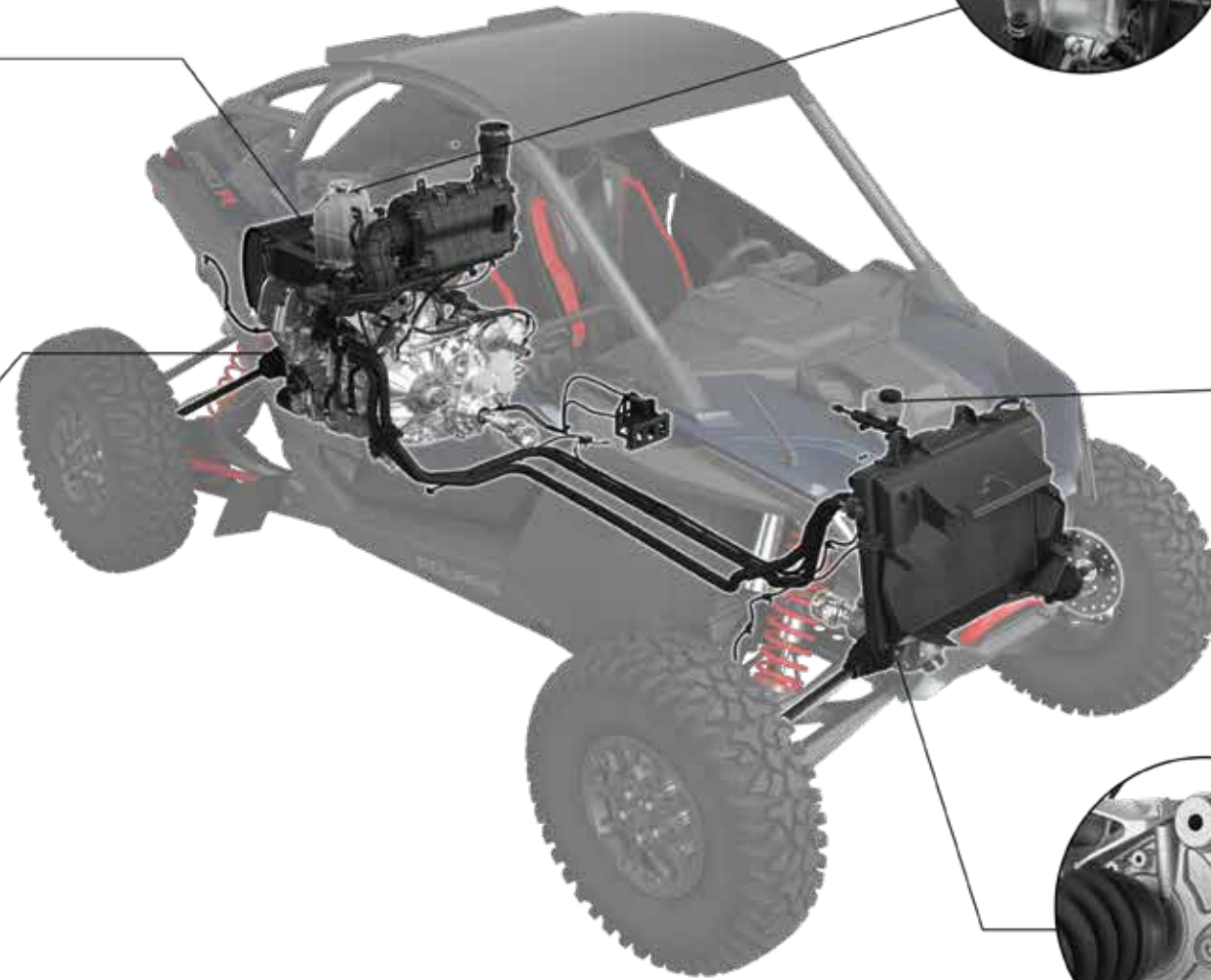

ANTI-FREEZE

Prevent corrosion on metal components, eliminate scaling and maximize cooling system performance.

- » 1 L • 502566
- » 25 L • 502567
- » 206 L • 502568



AGL

Protect gears, drive chain and bearings from scoring and wear.

- » 1 L • 502505
- » 25 L • 502507
- » 200 L • 502508



DOT 4 BRAKE FLUID

A high-quality brake fluid designed for use in Polaris hydraulic brakes.

- » 250 mL • 502526

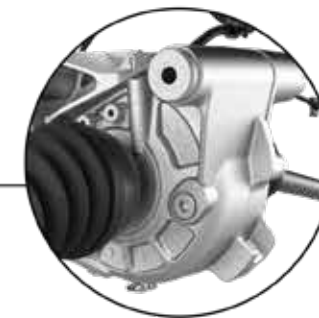

DEMAND DRIVE FLUID*

Provide positive 4WD engagement in extreme cold or high heat conditions and protect internal components under heavy loads.

- » 1 L • 502563
- » 25 L • 502564
- » 200 L • 502565



*RZR MODELS EXCEPT PRO R 4/ PRO R
PRO R 4 '22-23 & PRO R '22-23 REQUIRE ANGLE DRIVE FLUID (503320)



PREMIUM GAS SHOCK OIL

- » 1 L • 502518



ALL-SEASON GREASE TUBE

- Specialized water-resistant lubricant
- » 400 g • 502538



ANGLE DRIVE FLUID

- Extreme pressure, anti-wear and high viscosity film lubrication for maximum protection

- » 1 L • 502510
- » 25 L • 502511
- » 202 L • 502512

SPORTSMAN, RANGER, RZR
ANGLE DRIVE GEAR CASE SYSTEMS



CARBON CLEAN

- Ultimate fuel and injection system cleaner

- » 125 mL • 502528



FUEL STABILIZER

- Fuel Stabilizer prevents ethanol corrosion and stabilizes fuel for up to 2 years. Dual-antioxidant formula protects against gum and varnish for easy starting.

- » 125 mL • 502519

HD HEAVY DUTY PARTS

All Polaris parts are developed and tested to help you get the most out of your ride. We're taking the passion of our riders, workers and outdoor enthusiasts to the next level with HD Parts.

Engineered and designed for:

- Greater durability
- Enhanced performance
- Greater wear and tear capabilities
- All weather conditions

OIL FILTERS

The advanced synthetic material built into these filters offers the highest debris holding capacity, maintains oil flow and maximizes performance.

OE	HD HEAVY DUTY PARTS
2520799	2522498
2540086	2522485

WHEEL BEARINGS

Fully sealed for added protection against intrusions. Made of a higher grade steel for extended life in extreme conditions.

LOCATION	OE	HD HEAVY DUTY PARTS
FRONT WHEEL BEARINGS	3514924	3515090
REAR WHEEL BEARINGS	3414924	3515090

NEW BATTERY*

AGM fully sealed for optimal starting power with maximum reserve capacity, designed for highly accessorized vehicles and extreme operating conditions.

OE	HD HEAVY DUTY PARTS
4014132	4081855

*Check with your local dealer for availability.

DRIVE BELTS

The enhanced rubber material compound in these belts keep them cool in extreme heat, while our proprietary cord treatment process maximizes the transfer of horsepower to the ground for those customers hauling heavy loads.

OE	HD HEAVY DUTY PARTS
3211148	3212326
3211113	3212328

WHEELS & TIRES

Class leading durability for off road performance and traction for confident driving in extreme conditions.

- » 1524022-458 • HD WHEEL - 14x7"
- » 5417507 • PRO ARMOR HD-K - 29x10R14"
- » 5457498-458 • HD WHEEL CENTER CAP*
- » 5415756 • PRO ARMOR XD-K FRONT
- » 5415757 • PRO ARMOR XD-K REAR

* SHOWN

BUSHINGS

The advanced material compound of the bushings enables tighter tolerances to reduce overall wear on the system, while the superior triple lip sealing prevents intrusion of the elements.

LOCATION	OE	HD HEAVY DUTY PARTS
FRONT UPPER BUSHINGS	5439874	1543367
	5439730	1543326
	5436973	1543326
FRONT LOWER BUSHINGS	5439874	1543367
	5439730	1543326
	5436973	1543326
REAR UPPER BUSHINGS	5439874	1543367
	5439730	1543326
	5436973	1543326
REAR LOWER BUSHINGS	5439874	1543367
	5439730	1543367
UPPER HUB BUSHINGS	5436832	1543367

CV BOOT KIT

TPE rubber compound for maximum puncture and tear resistance, includes (1) boot, grease and clamp to replace OE stock part. Provides increased durability for riding in extreme conditions.

OE	HD HEAVY DUTY PARTS
2204102	2209922
3236165	2209923

BRAKE PADS

Engineered to provide longer life and better stopping power while riding in extreme conditions.

OE	HD HEAVY DUTY PARTS
2205949	2208933
2203318	2208936
2202413	2208934
2202412	2208935

BUSHING KITS

Easily update the entire front and rear suspension.

- » 2830564
- RZR 800 '08-'14, RZR 800 S '09-'14

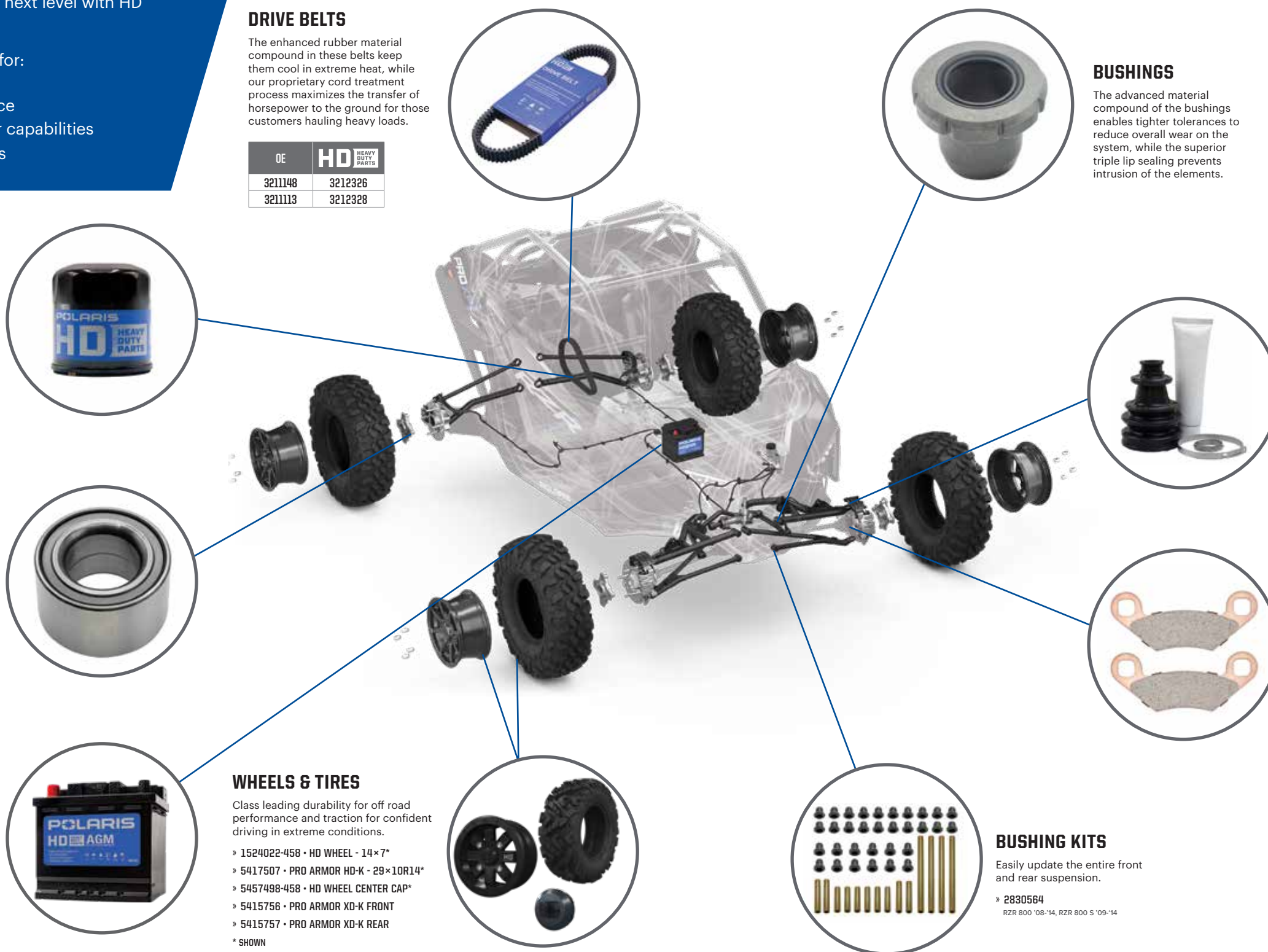

Claims made based off testing and performance of Polaris HD Parts against standard OEM parts made by Polaris and competitor brands under normal use.

For more information regarding Polaris HD parts including vehicle compatibility, installation and maintenance, please contact your authorized Polaris ORV dealer.



SAND



MUD



WATER



EXTREME COLD



EXTREME HEAT UP TO 54° C



HEAVY PAYLOADS



EXTENDED LIFE

PARTS & GARAGE

MAINTENANCE

OIL & LUBRICANTS

MAINTENANCE FLUIDS

HD PARTS

SERVICE PARTS

CLEANERS & TRAILERING

SERVICE PARTS

Polaris Engineered service parts deliver unmatched performance and fit for your off road vehicle.

All service parts are engineered specifically for your machine. Which means everything is designed, tested and perfected to maximize the life of your ride. Getting Polaris Engineered parts is a decision that pays off in the long run, because it ensures there is a long run.

VISIT YOUR POLARIS DEALER TO SHOP FOR SERVICE PARTS.

OVER
100,000
PARTS
AVAILABLE!



FOR THE LIFE OF YOUR RIDE

Maintenance is the key to keeping your Polaris off-road vehicle performing at its peak. Items like belts, lubricants, and batteries represent only a few of these critical items engineered specifically by Polaris.



POLARIS ENGINEERED DRIVE BELTS

TESTED, PERFECTED

We test each belt on the intended vehicle – we don't just try to make an existing belt "just work".
– Amery Kuhl, Polaris CVT System Engineer

OUR INVESTMENT

- 32,187 km of field testing
- Thousands of dyno hours
- 18+ months of development (3,000+ design hours) per belt
- 1,200+ vehicle validation hours
- Collaboration with powertrain & clutch engineers

YOUR ADVANTAGE

- No clutch recalibration
- Less wear & tear due to heat
- Ensure maximum performance of your vehicle
- More time out riding, less time wrenching

**OUR INVESTMENTS ENSURE POLARIS BELTS
OUTPERFORM YOUR EXPECTATIONS.**

KEEP IT CLEAN

CLEAN

ALL-PURPOSE CLEANER

- Professional cleaner, which is formulated with a low pH-value. The product spreads well on surfaces and adheres on them for effective cleaning action. Perfectly compatible with rubber, plastic and painted surfaces. The formulation is biodegradable.

» 500 mL • 502309

SHINE

INSTANT SHINE & DETAILER

- The INSTANT SHINE AND DETAILER is developed for cleaning action without water. Removes insects, dust and dirt with almost no effort. Applicable for plastics, visors, windscreens, paint and metal. The wipe and shine formulation makes surfaces shine, works water repellent and also has an antistatic effect. Perfect for customers living in urban areas with no access to water, for bike trips or showroom bikes.

» 500 mL • 502303



CV BOOT REPAIR KIT*

FIX ON THE GO | TEMPORARY COVERAGE

- A quick trail-side fix to increase trail time
- The flexible and durable boot material expands over a cone tool for CV boot repairs, without disassembling CV axles
- Universal fit – works as a temporary fix for most powersports axles
- All components fit inside the cone, and a cover is provided for compact durable storage
- Easily fits in a cargo box, attached to the roll cage, in the glovebox or many other storage locations



Items shown are contained inside cone

UTV CV BOOT REPAIR KIT

- Kit includes the following items:
- (1) Expandable XL CV Boot
 - (1) Reusable Cone Tool
 - (2) CV Boot Clamps
 - (1) Tube of Silicone Lube
 - (1) Grease Packet
 - (1) Cone Cover

» 2830526

UTV TRAIL BOOT ONLY

» 2830527

ATV

- » CV REPAIR KIT 2830528
- » TRAIL BOOT ONLY 2830529

HOW TO INSTALL

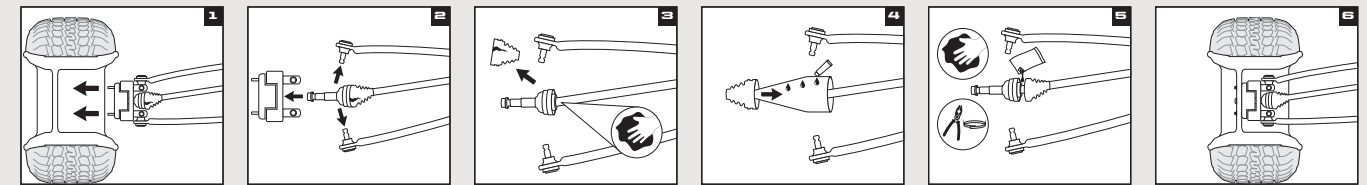

1. Remove wheel and axle nut.

2. Remove brake caliper, hub, tie rod and upper and lower ball joints.

3. Remove old boot and clean joint.

4. Spread silicone lube on entire cone tool. Slide boot over cone tool, large end first. See package for outer boot instructions.

5. Empty the bag of grease into the CV joint/boot, clean sealing points and install clamps.

6. Reassemble tie rod, ball joints, brake caliper, axle nut, tire and wheel.

Refer to your service manual for further instructions and torque specifications.
*Designed for temporary CV boot repair. Purchase the OEM CV Boot for a permanent repair.

BRING IT EVERYWHERE

TRAILERING



CALIBER RAMP PRO

- Designed for ATVs and UTVs up to 127 cm wide
- Integrated grip glides for ultimate traction
- Folding sides for easy transportation and storing

» 132 cm x 229 cm • 2884576



ALUMINUM ARCHED LOADING RAMPS

- Capacity for up to 1,361 kg
- » 193 cm x 30.5 cm • 907 KG • 2875384
- » 224 cm x 30.5 cm • 1,361 KG • 2875386



LIGHTWEIGHT TRI-FOLD RAMPS

- Ramp folds up for transport
- Capacity for up to 681 kg
- Safety straps included

» 183 cm x 130 cm • 2875385
» 208 cm x 130 cm • 2875860

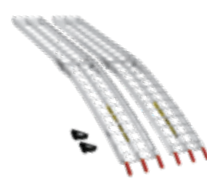

FOLDING ALUMINUM ARCHED RAMPS

- Ramp folds up for transport
- Up to 680 kg total capacity, 340 kg per individual ramp
- Safety straps included

» 224 cm x 30.5 cm • 2875387

COVERS

TRAILERABLE COVER BY POLARIS

PRO XP

» 4-SEAT • 2883989
PRO XP 4 '20-23

» 2-SEAT • 2883764
PRO XP '20-23

XP

» 4-SEAT • 2884522
XP 4 '24

» 2-SEAT • 2884521
XP '24

TRAIL S / TRAIL

» 2-SEAT • 2885092
TRAIL S '21-23, TRAIL '21-23



HITCHES



HITCH WITH 5 CM BALL

- 3:1 Hitch: Ball, hook and pin design
- Rust resistant steel with powdercoat finish
- Removable ball, HD 1.6 cm pin and clip

» 5 cm x 5 cm RECEIVER • 2830522
» 3 cm x 3 cm RECEIVER • 2830523



4.8 CM BALL

- 4.8 cm replacement ball for hitch
- Designed to work with 3:1 Hitch

» 2830524



RECEIVER HITCH

» 5 cm RECEIVER TONGUE • 2875320



TRAILER BALL 1.9 CM SHANK

» 4.8 cm BALL • 2877602
» 5 cm BALL • 2877603

STRAPS & ROPES



RECOVERY STRAP

- 5 cm x 9 m
- 8,165 kg maximum load, 4,082 kg maximum vehicle weight
- Comes with carry bag

» 2884033



RATCHET STRAP

- 3.8 cm x 4.6 m straps, 2-Pack
- Heavy duty webbing
- 2,495 kg maximum load, working load

» 2884031



RATCHET STRAP

- 5 cm x 6.1 m Ratchet Straps
- Heavy duty webbing, floating D-rings, double J-hooks
- 4,536 kg maximum load, 1,497 kg working load

» 2884032



SHOCK STRAPS

- 3.8 cm 1,361 kg breaking strength
- Keeps tension on tie-down straps to secure load

» 2-Pack
» 3.8 cm x 4.6 m • 2883296
» 3.8 cm x 2.1 m • 2883295



SPARE TIRE RATCHETING Y-STRAP

» 2889506



APPAREL

GEAR UP FOR YOUR ADVENTURE. Adventure invites you to gear up and make the most out of every moment, through the thrills, the fun and the memories. Live boldly on and off the trail with Polaris apparel and represent the brand that helps you get outside, stay outside, and THINK OUTSIDE.



HELMET

- Polycarbonate shell
- Removable & washable lining
- Double lens system with integrated sun visor

- Quick release micrometric adjustment system
- Weight: 1450 g (+/-50 g)

- 1 shell and 2 EPS: XS-M, L-XXL
- ECE 22-06 approved



White Gloss | XS-2XL | 2802311
Dark Gray Matte | XS-2XL | 2802312



BOOTS

- Waterproof and breathable lining
- Full-grain oil treated leather upper
- Specific ATV double density compound rubber sole
- Adjustable Velcro® closure

- Replaceable/adjustable plastic buckles
- Anti-bacterial replaceable footbed
- CE-approved motorcycle boots EN 13634:2017

Black | EU39-47 | 2802313
Brown | EU39-47 | 2802314



TECHNICAL SHIRT

- 100% polyester
- Indelible sublimated graphics
- Hemmed edging
- Lycra cuffs and collar

Black | S-3XL | 2802104



TECHNICAL JACKET

- Water-resistant jacket
- Ultra-light thanks to polyester ripstop and softshell for optimal comfort
- Ventilated lining
- Hydration hose outlet
- Zip ventilation system on body and back

Black | S-3XL | 2802301



TECHNICAL PANTS

- Water-resistant pants
- Ultra-light thanks to polyester ripstop, softshell and 1000-D Cordura stretch fabric on the back for optimal comfort
- 2 cargo type pockets
- Zip ventilation system
- Zip and Velcro® adjustment at the bottom of the pants

Black | S-3XL | 2802302



RAIN JACKET

- Polyester ripstop high tearing resistance
- PU coating 1000 mm
- Mesh lining
- Non-removable hood

Black | S-3XL | 2802005



PUFFY JACKET

- Top body and shoulder polyester woven 3000mm/3000gr + welded quilting
- Lower body nylon 380T downproof
- 80gr padding
- Inner elastic bottom tightening
- Two external pockets with easy-grab puller

Black | S-3XL | 2802303



PADDED JACKET

- Shoulder and hood softshell waterproof and breathable 3000 mm / 3000 gr
- Lower body and sleeve, polyester woven waterproof and breathable 3000 mm / 3000 gr
- Quilted lining with 80 gr padding
- Elasticized lower body tightening
- Two external pockets with easy-grab puller

Black | S-3XL | 2802306



RACING PARKA

- Waterproof and breathable 3000 mm / 3000 gr
- Quilted lining with 80 gr padding
- 2 upper body outer pockets and 2 bottom cargo pockets
- Sleeve pocket with lazer holes
- +TPU welded film on zipper

Black | S-3XL | 2802307



SAFETY GLOVES TOUCH

- CE-approved motorcycle glove EN 13594:2015
- Touch screen compatible
- Silicon print on fingers to improve grip
- Neoprene cuff with Velcro® tightening
- Reinforcements patches for safety and comfort

Khaki | S-3XL | 2802309
Black | XS-7,3XL-13 | 2802103



NEO GLOVES

- CE-approved motorcycle glove EN 13594:2015
- 100% synthetic neoprene glove
- Touch screen compatible
- Knuckle protected
- Reinforcements patches for safety and comfort

Black | XS-7,3XL-13 | 2802310



SF TECH GLOVES TOUCH

- CE-approved motorcycle glove EN 13594:2015
- Touch screen compatible
- Knuckle-protected
- Silicon print on fingers to improve grip
- Neoprene cuff with Velcro® tightening
- Reinforcements patches for safety and comfort

Khaki | S-3XL | 2802308
Black | XS-7,3XL-13 | 2802102



BODYWARMER

- Upper body and side panels in softshell waterproof and breathable 3000mm/3000g
- Lower body nylon downproof
- Padding 80 g
- Two external pockets with easy-grab puller

Khaki | S-3XL | 2802304
Black | S-3XL | 2802101



RACING SOFTSHELL

- Softshell waterproof and breathable 3000mm/3000g
- Removable hood
- Four external pockets with easy-grab puller

Khaki | S-3XL | 2802305
Black | S-3XL | 2802003



HYBRID JACKET

- Sleeves in softshell waterproof and breathable 3000mm/3000g
- Body nylon downproof
- Padding 80 g
- Three external pockets with easy-grab puller

Black | S-3XL | 2802004



HEATED APPAREL

Keep warm even on the coldest days with Polaris Heated Apparel. By keeping the heat close to your body, you can stay out for a longer, more comfortable ride. The Polaris Heated Apparel lineup includes the Heated Vest, Heated Base Layers and a Heated Glove Liner for both men and women. Easily control your heat setting with the touch of a button.



OFF ROAD RIDING JERSEYS

Mesh ventilated panels for maximum airflow
Elastic sleeves with non-restrictive cuffs

OFF ROAD RIDING GLOVES

Adjustable wrist closure for a custom fit
Silicon finger grips and neoprene knuckle protection



BLACK
JERSEY | S-3XL | 2862718
GLOVES | S-3XL | 2862726
YOUTH JERSEY | S-XL | 2862723

ORANGE
JERSEY | S-3XL | 2862719
GLOVES | S-3XL | 2862729

TEAL
JERSEY | S-3XL | 2862720
GLOVES | S-3XL | 2862727
YOUTH JERSEY | S-XL | 2862724

BLUE
JERSEY | S-3XL | 2862722
GLOVES | S-3XL | 2862728
YOUTH JERSEY | S-XL | 2862725



NECK GAITERS

Keep the sun off your neck and the dust off your face. Stretchy and seamless material that is UPF 15-18 for sun protection and moisture-wicking.

- **NEW** ■ Blue | One Size | 2833138
- Camo | One Size | 2861948
- Black | One Size | 2861953
- Red Retro | One Size | 2861950
- Lime | One Size | 2861952
- RZR Scenic | One Size | 2861949
- RZR Black | One Size | 2861951
- **NEW** ■ RZR Red | One Size | 2833139



WOMEN'S
Black | S-3XL | 2833036

MEN'S
Black | S-3XL | 2833022



Black | S-3XL | 2833044

HEATED VESTS

WARMTH WITH THE TOUCH OF A BUTTON

- Perfect for any outdoor activity
- Down-proof machine washable material with 160g of insulation for warmth with or without the heater turned on
- Powered by a small rechargeable battery (included) that can also be used to charge a cellphone; battery not machine washable, remove prior to washing
- Easily adjust between four heat settings for changing weather conditions with built-in buttons

HEATED GLOVE LINER

KEEP YOUR HANDS WARM ON FROSTY DAYS

- Designed to fit under all Polaris riding gloves for an extra layer of warmth to keep you out riding longer
- Easily adjust your heat level by pressing a button on the bottom part of the glove



WOMEN'S
Top | S-3XL | 2833033
Bottom | S-3XL | 2833034

MEN'S
Top | S-3XL | 2833031
Bottom | S-3XL | 2833032

HEATED BASE LAYERS

ADJUSTABLE HEAT CLOSE TO YOUR BODY, MAXIMUM COMFORT IN CHANGING CONDITIONS

- Intended for use as a base layer
- Features lightweight, moisture-wicking fabric to give you the most comfortable layering to wear on all of your cold weather adventures, on or off the trail
- Includes multiple heat panels for evenly distributed heat for maximum warmth and comfort
- Powered by a small rechargeable battery (included) that can be used to charge a cellphone; battery not machine washable, remove prior to washing
- Easily adjust between four heat settings for changing weather conditions with built-in buttons

ALTITUDE

509 ALTITUDE 2.0 HELMET

LIGHTWEIGHT DESIGN, PERFORMANCE-INFUSED STYLE AND GOPRO MOUNTING CAPABILITY

SHELL

- Thermoplastic poly alloy outer shell

WEIGHT

- Composite as low as 1,200g
- Carbon fiber as low as 1,150g

FEATURES

- Strong, lightweight construction of carbon fiber or composite
- Superior fit for all-day comfort
- Pro Series breath box for complete protection, removable for optimal air flow
- One-piece eyepoint creates draft-free seal with 509 goggles
- Magnetic Fidlock® chin-strap technology and integrated GOPRO® mount
- DOT- and ECE 22.05-approved

FIDLOCK®

FOR POLARIS

RED
XS-4XL
2833054



RADIANT GREEN
XS-4XL
2833051



BLACK
XS-4XL
2861469



CARBON FIBER
BLACK/LIME
XS-4XL
2861473



BLUE
XS-2XL
2833143

TENACITY

TENACITY 4.0 HELMET

COMBINATION OF MODERN STYLE AND PREMIUM PROTECTION WITH INCREDIBLE VALUE

SHELL

- Shock-resistant, injection-molded thermoplastic

WEIGHT

- 1,500g

FEATURES

- Through-flow, full-helmet ventilation
- ProClip quick release chin strap allows you to fasten the chin strap in seconds
- Removable breath box and removable, washable liner
- Tool-less adjustable roost shield
- DOT- and ECE 22.05-approved



RADIANT GREEN
XS-2XL
2833142



BLACK
XS-2XL
2861557



BLACK/GRAY
XS-2XL
2861558



WHITE/RED
XS-2XL
2861561



PINK
XS-2XL
2861562

TACTICAL

509 TACTICAL 2.0 HELMET

COMBINES STYLE WITH VERSATILITY FOR ULTIMATE COMFORT AND CONTROL

SHELL

- Shock-resistant, injection-molded thermoplastic

FEATURES

- Innovative Venturi Vent pulls moist air from helmet without cold wind coming in
- Eyepoint seal is co-integrated with the removable breath box and creates a draft-free seal with 509 goggles and a clear field of view
- Magnetic Fidlock® chin-strap technology
- DOT- and ECE 22.06-approved

FIDLOCK®

FOR POLARIS

PINK
XS-4XL
2833050



MATTE BLACK
XS-4XL
2862468



GRAY
XS-4XL
2862469



RED/BLACK
XS-4XL
2862467



ORANGE
XS-4XL
2862471

> GOGGLES



BLUE
2862562



BLACK
2862557

509 KINGPIN OFF ROAD GOGGLE

PREMIUM MATERIALS, ATTRACTIVE PRICE



FEATURES

- Oversized spherical lens delivers optimal peripheral vision
- Metal tear-off posts provide strength and durability
- Quick-change technology allows you to run the best lens tint for conditions



ORANGE
2862561



STEALTH
2862560

509 MX6 OFF ROAD GOGGLE

SUPER WIDE FIELD OF VIEW, ENGINEERED FOR DIRT



FEATURES

- PC outer lens with anti-scratch coating, and internal anti-fog coating
- Outriggers with latch system for quick lens change
- 45mm strap with silicone to hold strap in place



LIME
2862559



RED/BLACK
2862558

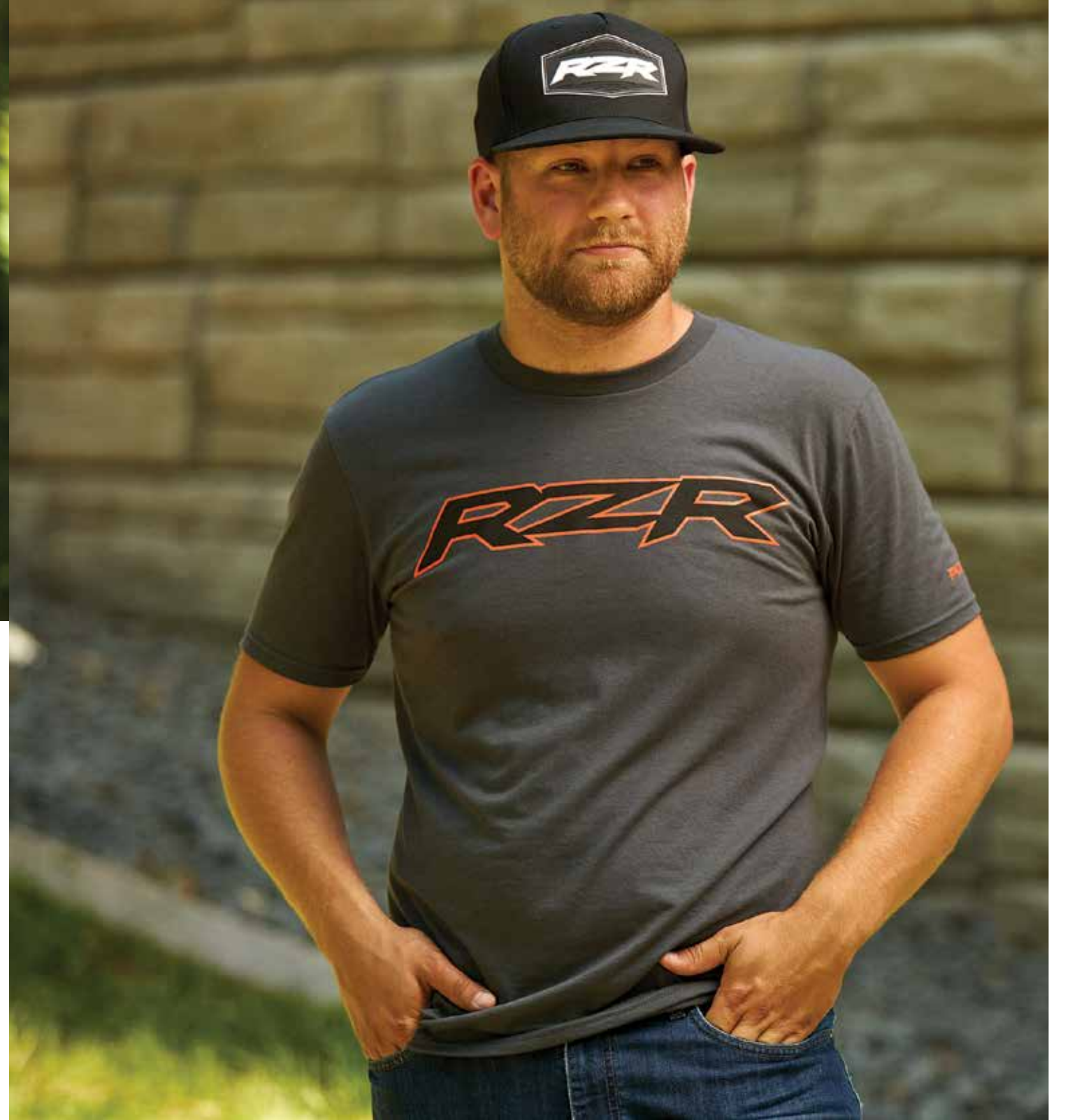

RZR VAPOR HOODIE

Black | S-3XL | 2862495
Gray | S-3XL | 2869593



RZR PERFORMANCE LONG SLEEVE

Royal | S-3XL | 2861935
Black | S-3XL | 2861934



RZR TEE

Gray | S-3XL | 2862509
Black/Red | S-3XL | 2861936



WOMEN'S RZR LIGHTWEIGHT HOODIE

Dusty Rose | S-3XL | 2862571
Sage | S-3XL | 2862731



WOMEN'S REPEAT TEE

Purple Frost | S-3XL | 2860711
Royal Heather | S-3XL | 2860712



WOMEN'S RZR TANK

Black | S-3XL | 2861945
Gray | S-3XL | 2861944



RZR PRO CAP

NEW Black | One Size | 2833135
Gray | One Size | 2862546



RZR PATCH HAT

Gray/Blue | S/M | 2861547
Gray/Blue | L/XL | 2861548
Gray/Orange | S/M | 2860609
Gray/Orange | L/XL | 2860610
Black/Red | S/M | 2860607
Black/Red | L/XL | 2860608



RZR FLAT BILL

Gray | One Size | 2862547
Black | One Size | 2862596
Navy | One Size | 2861546



RED/GRAY
S-3XL | 2833029



BLUE
S-3XL | 2833028



BLACK
S-3XL | 2861434

FORCE PUFFER JACKET

PACKABLE JACKET OFFERS LIGHTWEIGHT PROTECTION, IDEAL FOR ANY ACTIVITY

- 140g 3M[®] Thinsulate[®]
- Plenty of storage with two external hand pockets and one internal media pocket
- Rugged YKK[®] zippers
- Great for travel, compacts into pocket

SOFTSHELL JACKET

VERSATILE LIGHTWEIGHT JACKET THAT'S PERFECT FOR EVERYDAY WEAR

- Casual jacket armed with rugged and warm features for everyday wear
- Superior DWR prevents precipitation from saturating the jacket's exterior
- Lined with soft fleece for warmth
- Removable hood and underarm venting, three external pockets and one internal chest pocket

REVOLVE VEST

REVERSIBLE

DURABLE AND WARM REVERSIBLE VEST OFFERS TWO STYLES IN ONE

- Durable windbreak outer fabric helps protect from the elements
- 140g 3M[®] Thinsulate[®] insulation keeps you warm in cold weather
- Reversible vest offers two unique styles in one



RED
S-3XL | 2833030



BLACK/GRAY
S-3XL | 2862565



WORK VEST

RUGGED AND DURABLE VEST THAT'S IDEAL AS AN OUTDOOR LAYER

- Made of durable nylon fabric to make it the ideal vest for work
- 80g 3M[®] Thinsulate[®] Insulation provides great warmth
- Vest comes with plenty of pockets to store your valuables



BLACK
S-3XL | 2862569



FLANNEL JACKET

SHERPA FLEECE LINED JACKET DELIVERS EXCEPTIONAL WARMTH AND COMFORT

- Warm sherpa lined fleece material
- Insulation to keep you warm
- Plenty of storage for your valuables



CHARCOAL
S-3XL | 2860865



BRONZE
S-3XL | 2860864





STAMP HOODIE

Black | S-3XL | 2862484
Navy | S-3XL | 2861500



CREW SWEATSHIRT

Gray | S-3XL | 2833067
Black | S-3XL | 2862488



ICON HOODIE

Black/Red | S-3XL | 2833065
Gray | S-3XL | 2862487
Green | S-3XL | 2861495

APPAREL

RACING COLLECTION

JERSEYS & GLOVES
& HEATED APPAREL

HELMETS & GOGGLES

R2Z APPAREL

MEN'S APPAREL

BALL CAPS

CAMO APPAREL

WOMEN'S APPAREL

HOME
& COLLECTIBLES



TITAN MID-LAYER

Red | S-3XL | 2833026
Black | S-3XL | 2862568
Blue/Orange | S-3XL | 2862567



NORTHSTAR MID-LAYER

Black/Lime | S-3XL | 2833024
Tan | S-3XL | 2862450



JOURNEY HOODIE

Black | S-3XL | 2862489



ICON LONG SLEEVE

Lime | S-3XL | 2833083
Gray/Red | S-3XL | 2862505
Black | S-3XL | 2861584



DASH LONG SLEEVE

Black/Red | S-3XL | 2833082
Black | S-3XL | 2861582



PERFORMANCE LONG SLEEVE

NEW Gray/White | S-3XL | 2833324
NEW Royal Blue | S-3XL | 2833325
Gray | S-3XL | 2833168
Black | S-3XL | 2862507



STAPLE HOODIE

Black | S-3XL | 2833068
Navy | S-3XL | 2833069
Green | S-3XL | 2833070



TECH FULL-ZIP HOODIE

Red | S-3XL | 2833064
Gray | S-3XL | 2861493



ROGUE HOODIE

Black | S-3XL | 2833062
Navy | S-3XL | 2833063
Gray | S-3XL | 2862485



ICON TEE

Lime | S-3XL | 2833079
Green | S-3XL | 2862501
Black | S-3XL | 2861570



GRAPHIC TEE

Dark Gray | S-3XL | 2833086
Forest Green | S-3XL | 2833087



FLAG TEE

Navy | S-3XL | 2862500
White | S-3XL | 2862582

> BALL CAPS



LEATHER PATCH HAT

Black | One Size | 2833129
Gray | One Size | 2833130



STAPLE CAP

Black | One Size | 2833127
Navy | One Size | 2833128



HIGHLAND CAP

Navy | One Size | 2833126
Tan | One Size | 2833490
Gray | One Size | 2833506



ELLIPSE PATCH TRUCKER HAT

Orange | One Size | 2833124
Light Gray | One Size | 2833504
Gray | One Size | 2833498
Black | One Size | 2833500
Navy | One Size | 2833499



CORE CAP

Red | One Size | 2833123
Gray | One Size | 2833507
Navy | One Size | 2833494
Black | One Size | 2833495



TONAL HAT

Black/Red | One Size | 2833497
Navy | One Size | 2833496



JOURNEY CAP

Black | One Size | 2833136
Blue | One Size | 2833137



CHECKERED HAT

Blue | One Size | 2833491
Black | One Size | 2833493
Gray | One Size | 2833492



RETRO CAP

Black | One Size | 2833125
Navy | One Size | 2833503
Gray/Red | One Size | 2869542
Gray/Orange | One Size | 2833501

> CAMO APPAREL



CAMO SOFTSHELL JACKET

Camo | S-3XL | 2861543



MEN'S CAMO REVOLVE VEST

Camo | S-3XL | 2862572



MEN'S CAMO PURSUIT HOODIE

Camo | S-3XL | 2862494



WOMEN'S CAMO PURSUIT HOODIE

Camo | S-3XL | 2862517



PURSUIT HOODIE

Black | S-3XL | 2833076
Green | S-3XL | 2833077



CAMO NECK GAITER

Camo | One Size | 2861948



STEALTH CAMO HAT

Camo | One Size | 2861527



HUNTER ORANGE HAT

Orange | S/M | 2860892
Orange | L/XL | 2862545



HUNTER ORANGE BEANIE

Orange | One Size | 2862595



RADIANT GREEN
S-3XL | 2833039

BLACK
S-3XL | 2862457

BLACK
S-3XL | 2833041

RADIANT GREEN
S-3XL | 2833040

BLUE
S-3XL | 2862460

REVOLVE VEST

DURABLE AND WARM REVERSIBLE VEST OFFERS TWO STYLES IN ONE

- Durable windbreak outer fabric protects you from the elements
- 140g 3M® Thinsulate® insulation keeps you warm in cold weather
- Reversible for two unique styles in one



BLACK
S-3XL | 2861433

FORCE PUFFER JACKET

PACKABLE JACKET OFFERS LIGHTWEIGHT PROTECTION AND INCREDIBLE WARMTH

- 140g 3M® Thinsulate®
- Two external hand pockets, one internal media pocket
- Rugged YKK® zippers
- Compactable into travel pocket



BLACK
S-3XL | 2862563

BLUE
S-3XL | 2862564

WORK JACKET

WARM AND RUGGED JACKET THAT'S TOUGH FOR WORK AND STYLISH FOR PLAY

- 100% nylon shell is coated with DWR to help keep you dry
- 80g 3M® Thinsulate® for added warmth with brushed flannel trim
- Built-in action back for increased range of motion
- One inner and four outer pockets for storage



RADIANT GREEN
S-3XL | 2833042

BLACK/GRAY
S-3XL | 2862458

TITAN MID-LAYER

EXTREMELY WARM YET BREATHABLE MID-LAYER, PERFECT FOR RIDING

- 319g Polartec® Thermal Pro® Rib Sweater provides great warmth
- Breathable material moves sweat to the outer surface
- Nylon overlay is comfortable and light

SOFTSHELL JACKET

VERSATILE LIGHTWEIGHT JACKET THAT'S PERFECT FOR EVERYDAY WEAR

- Casual jacket armed with rugged and warm features
- Superior DWR prevents precipitation from saturating the jacket's exterior
- Lined with 280g of soft fleece for warmth
- Removable hood and underarm venting
- Three external pockets and one internal chest pocket



STAPLE HOODIE

Black | S-3XL | 2833095
Gray | S-3XL | 2833096



JOURNEY HOODIE

Radiant Green | S-3XL | 2833098
Black | S-3XL | 2862515
Blue | S-3XL | 2862516



TECH FULL-ZIP HOODIE

Black | S-3XL | 2833097
Gray | S-3XL | 2861508



ICON HOODIE

Gray | S-3XL | 2833099
White | S-3XL | 2862512



ADVENTURE CREW

Black/Radiant Green | S-2XL | 2833100
Green | S-2XL | 2833101
Dusty Rose | S-2XL | 2862513
Black | S-2XL | 2862514



ADVENTURE LONG SLEEVE

Gray | S-3XL | 2833107
Navy | S-3XL | 2833108



CORE TANK

Black | S-3XL | 2833161
Gray | S-3XL | 2833160



FLAG TEE

Gray | S-3XL | 2833163
White | S-3XL | 2833162



ADVENTURE TEE

Pink | S-3XL | 2833104
Black Frost | S-3XL | 2862628
Teal | S-3XL | 2862629



POLARIS RACING LED SIGN
35.6 cm x 22.8 cm | 2862737



POLARIS LED SIGN
35.6 cm x 91.4 cm | 2862736



ALUMINUM SIGN
55.9 cm | 2860867



WOOD SIGN
61 cm x 26.7 cm | 2860866



15oz CAMPFIRE MUG
2861613



12oz CAMPER MUG
2861612



23oz WATER BOTTLE
2862685



FLASK
2860812



PREMIUM KOOZIE
2860829



LEATHER LOOP KEYCHAIN
2861615



KEYCHAIN
2861614



DECK OF CARDS
2860816



KICKBACK ROCKER
2862626



FREESTYLE ROCKER
2862625



EASY CHAIR
2862627



QUICK-E-SEAT
2862624



FOLDABLE TABLE
2861620



POP-UP TRASH BIN
2861622



HITCH COVER
2861623



LICENSE PLATE HOLDER
2862687



POLARIS PARKING SIGN
2869934



POLARIS FLAG
3' x 5' | 2869928



RZR FLAG
3' x 5' | 2862684





MAKE IT YOUR RZR

DUNES

LIGHTING	P. 76
STORAGE	P. 32
PRO ARMOR WHEELS & TIRES	P. 84
ROOFS	P. 26
DOORS	P. 27

MUD

PRO ARMOR WHEELS & TIRES	P. 84
WINCHES	P. 55
DOORS	P. 47
ROOFS	P. 46
LIGHTING	P. 80
AUDIO	P. 42
STORAGE / COOLERS	P. 52

ROCK

PRO ARMOR WHEELS & TIRES	P. 84
VEHICLE PROTECTION	P. 28
WINCHES	P. 35
ROOFS	P. 26
STORAGE	P. 32

Availability varies by market, check your local dealer for availability. Images taken on private land. The use of vehicles in similar environments in your jurisdiction may be prohibited per locally applicable laws and regulations. Campfires in similar environments in your jurisdiction may be prohibited per locally applicable laws and regulations. Keep your campfire safe, and make sure you can control it at all times. Know your locally applicable laws and regulations. Crossing water in similar environments may be prohibited in your jurisdiction.

Warning: Polaris off road vehicles can be hazardous to operate and are not intended for on-road use. Driver must be at least 16 years old with a valid driver's license to operate. All riders should always wear helmets, eye protection and protective clothing and footwear. Read, understand and follow your owner's manual. Ride within the limits of your own abilities and never engage in stunt or exhibition driving. Never ride under the influence of drugs or alcohol. All riders should take a safety training course. Call 800-342-3764 for additional information.

UNLESS NOTED, TRADEMARKS ARE THE PROPERTY OF POLARIS INDUSTRIES INC. 3M® and Thinsulate® are registered trademarks of 3M Company. 509® is a registered trademark of Teton Outfitters, LLC. App Store® is a registered trademark of Apple Inc. BatteryMinder® is a registered trademark of VDC Electronics Inc. Bluetooth® is a registered trademark of Bluetooth Sig, Inc. Caliber® is a registered trademark of Caliber Products Inc. Facebook™ is a service trademark of Facebook, Inc. FOX® is a registered trademark of Fox Factory Inc. Fidlock® is a registered trademark of Fidlock GmbH. Google Play™ is a registered trademark of GOOGLE LLC. GoPro® is a registered trademark of GoPro Inc. High Lifter® is a registered trademark of NIVEL PARTS & MANUFACTURING CO., LLC. Instagram™ is a service trademark of Instagram, LLC. KING OF THE HAMMERS® is a registered trademark of Hammering Productions, Inc. KLIM® is a registered trademark of Teton Outfitters, LLC. MB Quart® is a registered trademark of Maxxsonics LLC. MORFLEX® is a registered trademark of FNA Group, Inc. NOCO Genius® is a registered trademark of The Noco Company. OGIO® is a registered trademark of Ogio International, Inc. Pandora® is a registered trademark of Pandora Media, LLC. Polartec® and Thermal Pro® are registered trademarks of MMI-IPCO, LLC. Proline Wraps® is a registered trademark of Andrew Madrid. RIGID® is a trademark of JST Performance, LLC d/b/a Rigid Industries LLC. Rockford Fosgate® is a registered trademark of Rockford Corporation. S&B® is a registered trademark of S&B Filters, Inc. SMART BOARD® is a registered trademark of SMART TECHNOLOGIES ULC UNLIMITED LIABILITY CORPORATION CANADA. Sparco® is a registered trademark of Sparco S.P.A. TEKVEST® is a registered trademark of 181876 ONTARIO INC. The Mint 400® is a registered trademark of THE MINT 400 CORPORATION. Tiger Drylac® is a registered trademark of TIGER COATINGS GMBH & CO. Twitter™ is a registered trademark of Twitter, Inc. Velcro® is a registered trademark of VELCRO IP HOLDINGS LLC. WALKER EVANS RACING® is a registered trademark of Walker Evans Enterprises Incorporated. Yeti® is a registered trademark of Yeti Coolers, LLC. YKK® is a registered trademark of YKK Corporation. YouTube® are registered trademarks of GOOGLE LLC. Prices, fitment and availability are subject to change at any moment. COPYRIGHT © 2023 POLARIS INDUSTRIES INC. ALL RIGHTS RESERVED.

RIDE OF YOUR LIFE



POLARIS
Think Outside

MY23 RZR APP ACC EMEA